



銅直接頭鍛造彎頭 BRASS JOINT AND FORGED BEND

代號：H：叉心 / M：外牙 / F：內牙 / S：喇叭口 / U：PU管

轉牙式 REVERSIBLE BARBED CONNECTOR



編號 ORDER NO.	規格 DIMENSION	牌價 PRICE	包裝 BAG	備註 NOTE
P000-A	1/4" F × 1/4" H		100	
P001	1/4" F × 5/16" H	20	200	
P002	3/8" F × 3/8" H	32	100	

塞頭 PLUG

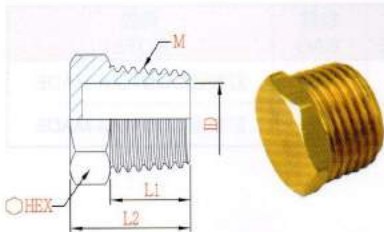

編號 ORDER NO.	規格 DIMENSION	M	ID	L1	L2	HEX.	牌價 PRICE	包裝 BAG	備註 NOTE
P003-2	1/4" M	1/4" M	9	10	15	14	11	100	
P003	3/8" M	3/8" M	12	11	16	17	15	50	
P004-1	1/2" M	1/2" M	15	12	17	20.7	22	50	
P004	3/4" M	3/4" M	20	11	16	27	35	30	
P004-2	1" M	1" M	26	15	21	35		30	

實心塞頭 PLUG SOLID

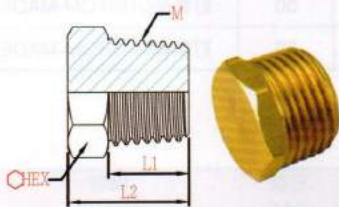

編號 ORDER NO.	規格 DIMENSION	M	L1	L2	HEX.	牌價 PRICE	包裝 BAG	備註 NOTE
P003-1	1/8" M	1/8" M	8.2	11.6	10		100	
P003-2-E	1/4" M	1/4" M	10	15	14		100	
P003-E	3/8" M	3/8" M	11	16	17		50	
P004-1-E	1/2" M	1/2" M	12	17	20.7		50	
P004-E	3/4" M	3/4" M	11	16	27		30	
P004-2-E	1" M	1" M	15	21	35		30	

大小接頭 內X外 FEMALE / MALE ADAPTOR

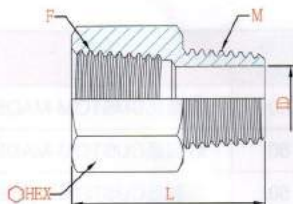

編號 ORDER NO.	規格 DIMENSION	F	M	ID	L	HEX.	牌價 PRICE	包裝 BAG	備註 NOTE
P005	1/8" F × 1/8" M	1/8" F	1/8" M	6	20	14	18	100	
P005-1	1/8" F × 1/4" M	1/8" F	1/4" M	8.4	23	14	19	100	
P005-2	1/8" F × 3/8" M	1/8" F	3/8" M	12	23	17	25	50	
P006-1	1/4" F × 1/8" M	1/4" F	1/8" M	6	24	17	22	100	
P006-2	1/4" F × 1/4" M	1/4" F	1/4" M	8.7	26	17	25	100	
P006-3	1/4" F × 3/8" M	1/4" F	3/8" M	11.5	26	17	25	100	
P006-4	1/4" F × 1/2" M	1/4" F	1/2" M	15	28	20.7	50	50	
P007	3/8" F × 1/8" M	3/8" F	1/8" M	6	24	20.5	31	50	
P007-1	3/8" F × 1/4" M	3/8" F	1/4" M	8.7	26	20.5	34	50	
P007-2	3/8" F × 3/8" M	3/8" F	3/8" M	12	26	20.5	34	50	
P007-3	3/8" F × 1/2" M	3/8" F	1/2" M	15	28	20.7	36	30	
P008-1	1/2" F × 1/4" M	1/2" F	1/4" M	8.7	28.5	25	49	30	
P008-2	1/2" F × 3/8" M	1/2" F	3/8" M	12	28.5	25	50	30	
P008	1/2" F × 1/2" M	1/2" F	1/2" M	15	30.5	25	53	30	
P009-1	3/4" F × 1/2" M	3/4" F	1/2" M	15	30.5	30		20	
P009-2	1/2" F × 3/4" M	1/2" F	3/4" M	18.5	32.5	27		20	
P009	3/4" F × 3/4" M	3/4" F	3/4" M	20	32.5	30		20	

* 本頁庫存品皆為PT牙，如需NPT牙、特殊牙需訂製。訂購量以包裝為準，不零售。
* 線圖尺寸僅供參考，詳細尺寸以現品為準。

銅直接頭鍛造彎頭

BRASS JOINT AND FORGED BEND

代號：H：叉心 / M：外牙 / F：內牙 / S：喇叭口 / U：PU管

雙面外牙接頭

TXT NIPPLE

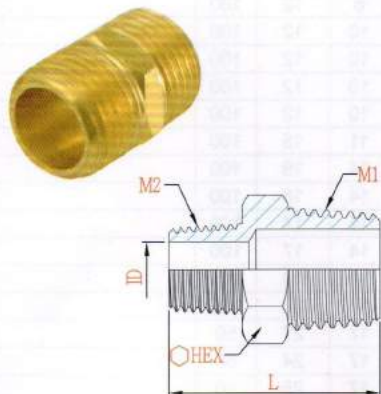

編號 ORDER NO.	規格 DIMENSION	M1	M2	ID	L	HEX.	牌價 PRICE	包裝 BAG	備註 NOTE
P010	1/8"M×1/8"M	1/8"M	1/8"M	6	21	10	10	100	
P011	1/4"M×1/8"M	1/4"M	1/8"M	6	23	14	15	100	
P012	1/4"M×1/4"M	1/4"M	1/4"M	8.7	25	14	16	100	
P013-1	3/8"M×1/8"M	3/8"M	1/8"M	6	25	17	20	100	
P013-2	3/8"M×1/4"M	3/8"M	1/4"M	8.7	27	17	22	100	
P013	3/8"M×3/8"M	3/8"M	3/8"M	12	27	17	23	100	
P014-0	1/2"M×1/8"M	1/2"M	1/8"M	6	26	20.7	31	50	
P014-1	1/2"M×1/4"M	1/2"M	1/4"M	8.7	28	20.7	31	50	
P014-2	1/2"M×3/8"M	1/2"M	3/8"M	12	28	20.7	31	50	
P014-3	1/2"M×1/2"M	1/2"M	1/2"M	15	30	20.7	35	50	
P014-4	3/4"M×1/2"M	3/4"M	1/2"M	15	33	27	57	30	
P014	3/4"M×3/4"M	3/4"M	3/4"M	19.5	33	27	61	30	
P014-6	1"M×3/4"M	1"M	3/4"M	19.5	41	35	118	30	
P014-7	1"M×1"M	1"M	1"M	25.5	44	35	127	20	
P014-8	1"M×1/2"M	1"M	1/2"M	15	38	35	101	30	
P014-9	3/4"M×1/4"M	3/4"M	1/4"M	8.7	31	27	59	30	
P014-5	3/4"M×3/8"M	3/4"M	3/8"M	12	31	27	59	30	
P014-10	1 1/4"M×1 1/4"M	1 1/4"M	1 1/4"M						訂製品CUSTOM-MADE

惠式粗牙

MALE BARBED CONNECTOR

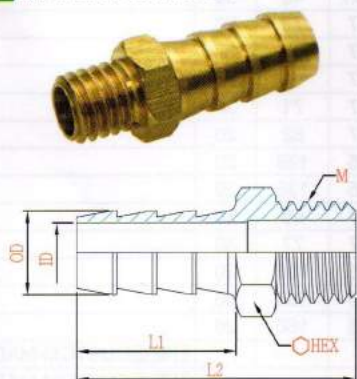

編號 ORDER NO.	規格 DIMENSION	M	ID	OD	L1	L2	HEX.	牌價 PRICE	包裝 BAG	備註 NOTE
P016-0	W3/8"M×5/16"H	W3/8"M	6.3	9	20	33	10	20	100	
P016-1	W3/8"M×3/8"H	W3/8"M	7.5	10.5	20	33	11	20	100	
P016-2	W3/8"M×1/2"H	W3/8"M	10.5	13.5	20	33	14	25	100	
P016-3	W1/2"M×3/8"H	W1/2"M	7.5	10.5	20	36	14	30	100	
P016-4	W1/2"M×1/2"H	W1/2"M	10.5	13.5	20	36	14	35	100	

氧氣乙炔用接頭

BARBED ADAPTOR OXYGEN ACEYLENE GAS



編號 ORDER NO.	規格 DIMENSION	牌價 PRICE	包裝 BAG	備註 NOTE
P027-02(反牙)	5/16"	16	100	ANTI-CLOCKWISE
P027-01(正牙)	5/16"	16	100	CLOCKWISE
P027-03(心)	3/16"	12	200	
P027-04(心)	5/16"		100	

※本頁庫存品皆為PT牙，如需NPT牙、特殊牙需訂製。訂購量以包裝為準，不零售。
※線圖尺寸僅供參考，詳細尺寸以現品為準。



銅直接頭鍛造彎頭 BRASS JOINT AND FORGED BEND

代號：H：叉心 / M：外牙 / F：內牙 / S：喇叭口 / U：PU管

管牙插心 MALE BARBED CONNECTOR

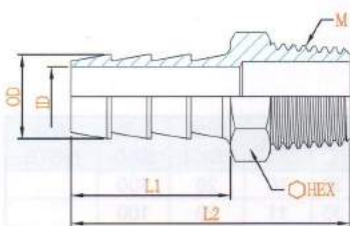

編號 ORDER NO.	規格 DIMENSION	M	ID	OD	L1	L2	HEX.	牌價 PRICE	包裝 BAG	備註 NOTE
P015-1	M5M×4m/mH	M5M	2.4	4	12	24	6	12	100	
P015-2	M5M×6m/mH	M5M	3.5	6	12	24	6	12	100	
P015-3	1/8"M×1/8"H	1/8"M	2.4	3.7	12	24	10	12	100	
P015-0	1/8"M×3/16"H	1/8"M	3	5.2	12	24	10	12	100	
P015	1/8"M×1/4"H	1/8"M	4.5	7	20	32	10	12	100	
P017	1/8"M×5/16"H	1/8"M	6.3	9	20	32	10	12	100	
P017-1	1/8"M×3/8"H	1/8"M	7.5	10.5	20	32	11	15	100	
P017-2	1/8"M×1/2"H	1/8"M	10	13.5	20	32	14	19	100	
P018-1	1/4"M×3/16"H	1/4"M	3	5.2	12	27	14	18	100	
P018-2	1/4"M×1/4"H	1/4"M	4.5	7	20	35	14	17	100	
P018	1/4"M×5/16"H	1/4"M	6.3	9	20	35	14	17	100	
P019	1/4"M×3/8"H	1/4"M	7.5	10.5	20	35	14	18	100	
P019-1	1/4"M×1/2"H	1/4"M	10	13.5	20	35	14	20	100	
P019-2	1/4"M×5/8"H	1/4"M	13.5	17	20	35	17	27	50	
P020-1	3/8"M×1/4"H	3/8"M	4.5	7	20	36	17	24	50	
P020	3/8"M×5/16"H	3/8"M	6.3	9	20	36	17	25	50	
P021	3/8"M×3/8"H	3/8"M	7.5	10.5	20	36	17	25	50	
P021-1	3/8"M×1/2"H	3/8"M	10.5	13.5	20	36	17	26	50	
P021-2	3/8"M×5/8"H	3/8"M	13.5	17	20	36	17	27	50	
P021-3	3/8"M×3/4"H	3/8"M	15.5	20	20	36	20.5	38	50	
P022-1	1/2"M×3/16"H	1/2"M	3	5.2	20	38	20.7	35	50	
P022-2	1/2"M×1/4"H	1/2"M	4.5	7	20	38	20.7	35	50	
P022	1/2"M×5/16"H	1/2"M	6.3	9	20	38	20.7	35	50	
P023	1/2"M×3/8"H	1/2"M	7.5	10.5	20	38	20.7	36	50	
P024	1/2"M×1/2"H	1/2"M	10.5	13.5	20	38	20.7	37	50	
P024-1	1/2"M×5/8"H	1/2"M	13.5	17	20	38	20.7	38	50	
P024-2	1/2"M×3/4"H	1/2"M	15	20	20	38	20.7	40	50	
P024-3	3/4"M×3/4"H	3/4"M	15.5	20	24	45	27	70	30	
P024-4	3/4"M×3/8"H	3/4"M	7.5	10.5	20	41	27	66	30	
P024-5	3/4"M×1/2"H	3/4"M	10.5	13.5	20	41	27	69	30	
P024-6	3/4"M×5/8"H	3/4"M	13.5	17	23	44	27	71	30	
P024-7	3/4"M×1"H	3/4"M	21	26.5	25	46	27	82	20	
P024-8	1"M×3/4"H	1"M	15.5	20	24	51	35	129	20	
P024-9	1"M×1"H	1"M	21	26.5	25	52	35	136	20	
P024-10	3/4"M×5/16"H	3/4"M	6.3	9	20	41	27	69	30	
P024-11	1/2"M×1"H	1/2"M	21	26.5	25	43	27	77	30	
P024-12	1"M×3/8"H	1"M	7.5	10.5	20	47	35	150	20	
P024-13	1"M×1/2"H	1"M	10.5	13.5	20	47	35	150	20	
P024-14	1"M×5/8"H	1"M	13.5	17	23	50	35	160	20	
P024-15	1"M×1 1/4"H	1"M								訂製品CUSTOM-MADE
P024-16	1"M×1 1/2"H	1"M								訂製品CUSTOM-MADE
P024-17-1	1 1/4"M×3/4"H	1 1/4"M								訂製品CUSTOM-MADE
P024-17-2	1 1/4"M×1"H	1 1/4"M								訂製品CUSTOM-MADE
P024-17-3	1 1/4"M×1 1/4"H	1 1/4"M								訂製品CUSTOM-MADE
P024-17-4	1 1/4"M×1 1/2"H	1 1/4"M								訂製品CUSTOM-MADE
P024-18-1	1 1/2"M×1"H	1 1/2"M								訂製品CUSTOM-MADE
P024-18-2	1 1/2"M×1 1/4"H	1 1/2"M								訂製品CUSTOM-MADE
P024-18-3	1 1/2"M×1 1/2"H	1 1/2"M								訂製品CUSTOM-MADE

※本頁庫存品皆為PT牙，如需NPT牙、特殊牙需訂製。訂購量以包裝為準，不需賣。
※線圖尺寸僅供參考，詳細尺寸以現品為準。

銅直接頭鍛造彎頭

BRASS JOINT AND FORGED BEND

代號：H：叉心 / M：外牙 / F：內牙 / S：喇叭口 / U：PU管

直通

DOUBLE BARBED CONNECTOR

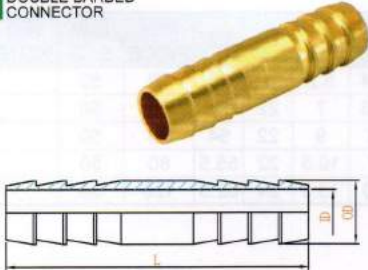

編號 ORDER NO.	規格 DIMENSION	ID	OD	L	牌價 PRICE	包裝 BAG	備註 NOTE
P030	3/16"H×3/16"H	3	5.2	43	9	200	
P030-1	1/4"H×1/4"H	4.5	7	43	11	200	
P031	5/16"H×5/16"H	6.3	9	50	14	100	
P032	3/8"H×3/8"H	7.5	10.5	50	18	100	
P033	1/2"H×1/2"H	10.5	13.5	50	25	100	
P033-1	5/8"H×5/8"H	13	17	50	36	50	
P033-2	3/4"H×3/4"H	15.5	20	50	49	30	

Y型插心

BARBED BRANCH TEE



編號 ORDER NO.	規格 DIMENSION	ID	OD	L1	L2	牌價 PRICE	包裝 BAG	備註 NOTE
P034-1	Y3/16"H×3/16"H×3/16"H	3.4	5.2	14.5	23	42	100	
P034-2	Y1/4"H×1/4"H×1/4"H	4.5	7	18	33.5	42	100	
P034	Y5/16"H×5/16"H×5/16"H	6	9	20	35.5	36	50	
P035	Y3/8"H×3/8"H×3/8"H	7	10.5	20	38	45	50	
P036	Y1/2"H×1/2"H×1/2"H	10	13.5	22	42	80	50	

L雙插心

BARBED BRANCH ELBOW

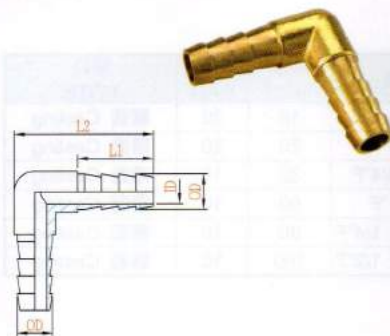

編號 ORDER NO.	規格 DIMENSION	ID	OD	L1	L2	牌價 PRICE	包裝 BAG	備註 NOTE
P036-1	L3/16"H×3/16"H	3.2	5.2	18	32	35	100	
P036-2	L1/4"H×1/4"H	4.5	7	20	34	35	100	
P036-3	L5/16"H×5/16"H	6	9	20	38.1	35	50	
P036-4	L3/8"H×3/8"H	7	10.5	20	38.1	40	50	
P036-5	L1/2"H×1/2"H	10	13.5	22	42	65	50	

T型插心

CROSSES TEE BARBED

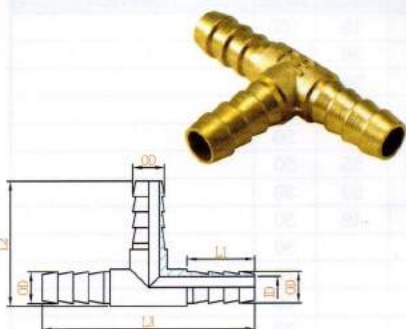

編號 ORDER NO.	規格 DIMENSION	ID	OD	L1	L2	L3	牌價 PRICE	包裝 BAG	備註 NOTE
P037-1A	T3/16"H×3/16"H×3/16"H	3.4	5.2	14.5	23	39.5	42	100	
P037-1	T1/4"H×1/4"H×1/4"H	4.5	7	20	31	52	42	100	
P037	T5/16"H×5/16"H×5/16"H	6	9	20	32	54	36	50	
P038	T3/8"H×3/8"H×3/8"H	7	10.5	20	35	58	45	50	
P038-1	T1/2"H×1/2"H×1/2"H	10	13.5	22	38	64	80	50	
P038-2	T5/8"H×5/8"H×5/8"H								訂製品 Custom-Made
P038-3	T3/4"H×3/4"H×3/4"H								訂製品 Custom-Made

※ 本頁庫存品皆為PT牙，如需NPT牙、特殊牙需訂製。訂購量以包裝為準，不需費。
 ※ 線圖尺寸僅供參考，詳細尺寸以現品為準。



銅直接頭鍛造彎頭 BRASS JOINT AND FORGED BEND

代號：H：叉心 / M：外牙 / F：內牙 / S：喇叭口 / U：PU管

十字通 BARBED CROSSES

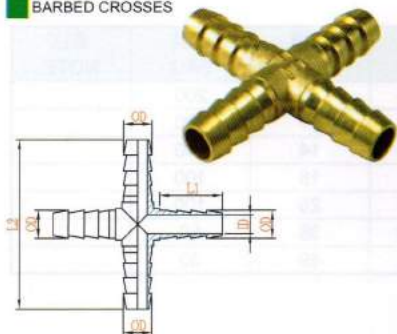

編號 ORDER NO.	規格 DIMENSION	ID	OD	L1	L2	牌價 PRICE	包裝 BAG	備註 NOTE
P039-1	+ 3/16"H×3/16"H×3/16"H×3/16"H	3.4	5.2	14.5	40	80	50	
P039	+1/4"H×1/4"H×1/4"H×1/4"H	4.5	7	22	54	80	50	
P040	+5/16"H×5/16"H×5/16"H×5/16"H	6	9	22	54	70	50	
P041	+3/8"H×3/8"H×3/8"H×3/8"H	7	10.5	22	55.5	80	50	
P042	+1/2"H×1/2"H×1/2"H×1/2"H	10	13.5	24	62.5	120	30	

卜申 FEMALE / MALE REDUCER

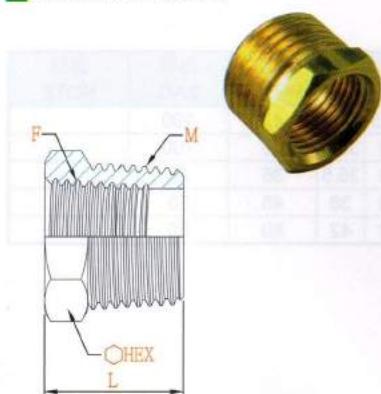

編號 ORDER NO.	規格 DIMENSION	F	M	L	HEX.	牌價 PRICE	包裝 BAG	備註 NOTE
P043	1/4"M×1/8"F	1/8"F	1/4"M	15	14	12	100	
P044	3/8"M×1/8"F	1/8"F	3/8"M	16	17	19	100	
P045	3/8"M×1/4"F	1/4"F	3/8"M	16	17	16	100	
P045-1	1/2"M×1/8"F	1/8"F	1/2"M	17	20.7	32	50	
P046	1/2"M×1/4"F	1/4"F	1/2"M	17	20.7	25	50	
P047	1/2"M×3/8"F	3/8"F	1/2"M	17	20.7	22	50	
P048	3/4"M×3/8"F	3/8"F	3/4"M	20	27	47	50	
P049	3/4"M×1/2"F	1/2"F	3/4"M	20	27	43	50	
P049-1	3/4"M×1/4"F	1/4"F	1"M	20	27	52	50	
P049-2	1"M×1/2"F	1/2"F	1"M	26	35	104	20	
P049-3	1"M×3/4"F	3/4"F	1"M	26	35	87	20	
P049-4	1"M×1/4"F	1/4"F	1"M	26	35		20	
P049-5	1"M×3/8"F	3/8"F	1"M	26	35		10	

銅卜申 FEMALE / MALE REDUCER



編號 ORDER NO.	規格 DIMENSION	A	B	牌價 PRICE	包裝 BAG	備註 NOTE
P49-4	1/2"M X 1/4"~3/8"F	1/2"M	1/4"~3/8"F	18	20	鑄造 Casting
P49-5	3/4"M X 1/2"F	3/4"M	1/2"F	20	20	鑄造 Casting
P49-6	1"M X 1/2"~3/4"F	1"M	1/2"~3/4"F	32	15	鑄造 Casting
P49-7	1 1/4"M X 1/2"~1"F	1 1/4"M	1/2"~1"F	60	10	鑄造 Casting
P49-8	1 1/2"M X 1/2"~1 1/4"F	1 1/2"M	1/2"~1 1/4"F	80	10	鑄造 Casting
P49-9	2"M X 1/2"~1 1/2"F	2"M	1/2"~1 1/2"F	100	10	鑄造 Casting

雙內牙 DOUBLE FEMALE ADAPTER

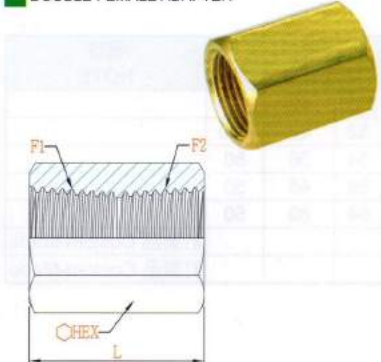

編號 ORDER NO.	規格 DIMENSION	F1	F2	L	HEX.	牌價 PRICE	包裝 BAG	備註 NOTE
P050	1/8"F×1/8"F	1/8"F	1/8"F	20	14	18	100	
P051	1/4"F×1/8"F	1/4"F	1/8"F	23	17	26	100	
P052	1/4"F×1/4"F	1/4"F	1/4"F	23	17	24	100	
P052-1	3/8"F×1/8"F	3/8"F	1/8"F	23	20.5	35	50	
P053	3/8"F×1/4"F	3/8"F	1/4"F	25	20.5	34	50	
P054	3/8"F×3/8"F	3/8"F	3/8"F	25	20.5	55	50	
P055	1/2"F×1/4"F	1/2"F	1/4"F	27	25	53	30	
P056	1/2"F×3/8"F	1/2"F	3/8"F	27	25	49	30	
P057	1/2"F×1/2"F	1/2"F	1/2"F	27	25		30	
P057-1	3/4"F×3/4"F	3/4"F	3/4"F	31	30		20	
P057-2	3/4"F×3/8"F	3/4"F	3/8"F	27	30		20	
P057-3	3/4"F×1/2"F	3/4"F	1/2"F	31	30		20	

※本頁庫存品皆為PT牙，如需NPT牙、特殊牙需訂製。訂購量以包裝為準，不零售。
※線圖尺寸僅供參考，詳細尺寸以現品為準。

銅直接頭鍛造彎頭

BRASS JOINT AND FORGED BEND

代號：H：叉心 / M：外牙 / F：內牙 / S：喇叭口 / U：PU管



內牙插心

FEMALE PIPE THREAD

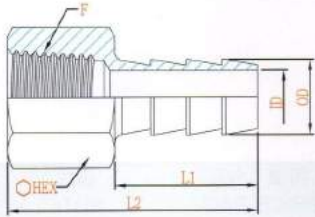

編號 ORDER NO.	規格 DIMENSION	F	ID	OD	L1	L2	HEX.	牌價 PRICE	包裝 BAG	備註 NOTE
P058-0	1/8"F×5/16"H	1/8"F	6.3	9	20	32	12	20	100	
P058-1	1/8"F×1/4"H	1/8"F	4.5	7	20	32	12	27	100	
P058-3	1/8"F×3/8"H	1/8"F	7.5	10.5	20	32	12	22	100	
P058-2	1/4"F×1/4"H	1/4"F	4.5	7	20	35	17	24	100	
P058	1/4"F×5/16"H	1/4"F	6.3	9	20	35	17	27	100	
P059	1/4"F×3/8"H	1/4"F	7.5	10.5	20	35	17	32	100	
P059-0	1/4"F×1/2"H	1/4"F	10.5	13.5	20	35	17	27	100	
P059-1	3/8"F×5/16"H	3/8"F	6.3	9	20	35	20.5	39	50	
P059-2	3/8"F×3/8"H	3/8"F	7.5	10.5	20	35	20.5	39	50	
P059-3	3/8"F×1/2"H	3/8"F	10.5	13.5	20	35	20.5	39	50	
P059-4	1/2"F×5/16"H	1/2"F	6.3	9	20	37.5	24	52	50	
P059-5	1/2"F×1/2"H	1/2"F	10.5	13.5	20	37.5	24	54	50	
P059-6	1/2"F×5/8"H	1/2"F	13.5	17	20	37.5	24	55	50	
P059-7	1/2"F×3/4"H	1/2"F	15.5	20	20	37.5	24	57	30	
P059-8	1/2"F×3/8"H	1/2"F	7.5	10.5	20	37.5	24	53	50	

90°管牙插心

MALE PIPE THREAD 90° ELBOW

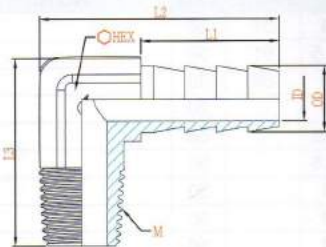

編號 ORDER NO.	規格 DIMENSION	M	ID	OD	L1	L2	L3	HEX.	牌價 PRICE	包裝 BAG	備註 NOTE
P060-1	1/8"M×3/16"H	1/8"M	3.2	5.5	20	33.3	24	9	26	100	
P060	1/8"M×1/4"H	1/8"M	4.1	7	20	33.3	24	9	26	100	
P061	1/8"M×5/16"H	1/8"M	6	9	20	33.5	24	9	29	100	
P061-1	1/8"M×3/8"H	1/8"M	7	10.5	19.5	34	24	9	30	100	
P062	1/4"M×1/4"H	1/4"M	4.1	7	20	38	29.5	12	43	50	
P063	1/4"M×5/16"H	1/4"M	6	9	20	38	29.5	12	43	50	
P064	1/4"M×3/8"H	1/4"M	7	10.5	22	38	29.5	12	44	50	
P064-1	1/4"M×1/2"H	1/4"M	10	13.5	22	40	31.5	12	46	50	
P065-1	3/8"M×1/4"H	3/8"M	4.1	7	20	38.2	29	12	46	50	
P065	3/8"M×5/16"H	3/8"M	6	9	20	38.2	29	12	45	50	
P066	3/8"M×3/8"H	3/8"M	7	10.5	22	38.2	29	12	57	50	
P066-1	3/8"M×1/2"H	3/8"M	10	13.5	22	40.6	31.5	13	55	50	
P066-2	3/8"M×5/8"H	3/8"M	11	17	19	38.5	32.5	13.5	65	50	
P067	1/2"M×5/16"H	1/2"M	6	9	20	40.5	33.5	13.3	70	50	
P068	1/2"M×3/8"H	1/2"M	7	10.5	22	41	33.5	13.3	73	50	
P069	1/2"M×1/2"H	1/2"M	10	13.5	22	42.5	33.5	13.3	71	50	
P069-1	1/2"M×5/8"H	1/2"M	12.3	17	22	42.7	34.2	14.5	109	30	
P069-2	1/2"M×3/4"H	1/2"M	15.9	20.2	22	51	43.8	20.5	120	30	
P069-3	3/4"M×3/8"H	3/4"M	7	10.5	22	51	45	20.5	170	20	
P069-4	3/4"M×1/2"H	3/4"M	10	13.5	22	51	45	20.5	170	20	
P069-5	3/4"M×5/8"H	3/4"M	12.3	17	22	51	45	20.5	170	15	
P069-6	3/4"M×3/4"H	3/4"M	15.9	20.2	22	51	45	20.5	170	15	
P069-7	3/4"M×1"H	3/4"M	21.5	26.5	27	59	51.5	27	190	10	
P069-8	1"M×3/4"H	1"M	15.9	20.2	22	58	57.2	27	260	10	
P069-9	1"M×1"H	1"M	21.5	26.5	28	61	57.2	27	260	10	

90°內牙插心

90° FEMALE PIPE THREAD

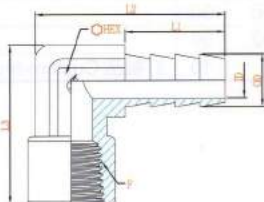

編號 ORDER NO.	規格 DIMENSION	F	ID	OD	L1	L2	L3	HEX.	牌價 PRICE	包裝 BAG	備註 NOTE
P069-11	1/8"F×1/4"H	1/8"F	4.1	7	20	38	29.5	12	43	100	
P069-12	1/4"F×1/4"H	1/4"F	4.1	7	20	38.1	29	12	48	100	
P069-12-B	1/4"F×5/16"H	1/4"F	6	9	20	38.1	29	12		100	
P069-13	1/4"F×3/8"H	1/4"F	7	10.5	20	38.1	29	12	57	100	
P069-14	1/4"F×1/2"H	1/4"F	10	13.5	22	41.8	33.5	13	55	50	
P069-15	3/8"F×3/8"H	3/8"F	7	10.5	22	41	33.5	13.3	73	50	
P069-16	3/8"F×1/2"H	3/8"F	10	13.5	22	42.5	33.5	13.3	73	30	
P069-17	1/2"F×1/2"H	1/2"F	10	13.5	22	51	44.2	20.5		10	

※本頁庫存品皆為PT牙，如需NPT牙、特殊牙需訂製。訂購量以包裝為準，不零售。
※線圖尺寸僅供參考，詳細尺寸以現品為準。



銅直接頭鍛造彎頭 BRASS JOINT AND FORGED BEND

代號：H：叉心 / M：外牙 / F：內牙 / S：喇叭口 / U：PU管

惠式90°插管 MALE / BARBED ELBOW

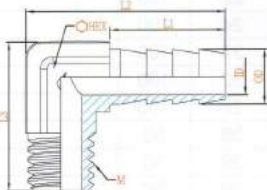

編號 ORDER NO.	規格 DIMENSION	M	ID	OD	L1	L2	L3	HEX.	牌價 PRICE	包裝 BAG	備註 NOTE
P016-5	W3/8" M × 5/16" H	W3/8" M	6	9	20	33.5	22	9	45	100	訂製品 Custom-Made
P016-6	W3/8" M × 3/8" H	W3/8" M	7	10.5	19.5	34	22	9	45	100	訂製品 Custom-Made
P016-7	W3/8" M × 1/2" H	W3/8" M	10	13.5	22	40	28	12	50	50	訂製品 Custom-Made
P016-8	W1/2" M × 3/8" H	W1/2" M	7	10.5	22	38	28.5	12	60	50	訂製品 Custom-Made
P016-9	W1/2" M × 1/2" H	W1/2" M	10	13.5	22	40	30	12	65	50	訂製品 Custom-Made

90°雙外 MALE ELBOW

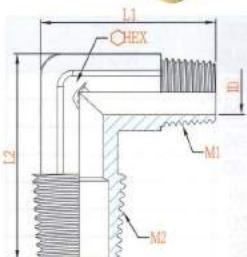

編號 ORDER NO.	規格 DIMENSION	M1	M2	ID	L1	L2	HEX.	牌價 PRICE	包裝 BAG	備註 NOTE
P070	1/8" M × 1/8" M	1/8" M	1/8" M	5.5	25.4	25.4	9.5	29	100	
P071	1/4" M × 1/8" M	1/8" M	1/4" M	5.5	27.5	29.7	10	35	100	
P072	1/4" M × 1/4" M	1/4" M	1/4" M	8.5	30	30	10	37	100	
P073	3/8" M × 1/4" M	1/4" M	3/8" M	8.5	30.5	30.5	11	50	50	
P074	3/8" M × 3/8" M	3/8" M	3/8" M	11	32.1	32.1	13	59	50	
P075	1/2" M × 1/4" M	1/4" M	1/2" M	8	33.2	36	13	65	50	
P076	1/2" M × 3/8" M	3/8" M	1/2" M	11	32.2	35.2	13	78	50	
P077	1/2" M × 1/2" M	1/2" M	1/2" M	14	36.4	36.4	14	87	30	
P077-1	3/4" M × 3/4" M	3/4" M	3/4" M	19.1	46.1	46.1	21		15	

90° (煙斗型) 內外接頭 90° FEMALE / MALE STREET ELBOW

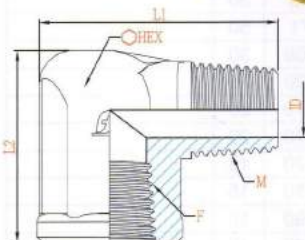

編號 ORDER NO.	規格 DIMENSION	F	M	ID	L1	L2	HEX.	牌價 PRICE	包裝 BAG	備註 NOTE
P078	1/8" M × 1/8" F	1/8" F	1/8" M	5.5	27.8	23.1	14	37	50	
P079	1/4" M × 1/4" F	1/4" F	1/4" M	8	34.5	27.8	18.5	61	50	
P080	3/8" M × 3/8" F	3/8" F	3/8" M	11	42.2	29.5	21	86	30	
P080-1	1/2" M × 1/2" F	1/2" F	1/2" M	14	46.3	32	24		20	
P078-1	1/4" M × 1/8" F	1/8" F	1/4" M	8	34.5	27.8	18.5		50	
P079-1	1/8" M × 1/4" F	1/4" F	1/8" M	5.5	33.2	27.8	18.5		50	
P079-2	3/8" M × 1/4" F	1/4" F	3/8" M	11	42.2	29.5	21		50	
P080-2	1/8" M × 3/8" F	3/8" F	1/8" M	5.5	39.4	29.5	21		50	
P080-3	1/4" M × 3/8" F	3/8" F	1/4" M	8	40.7	29.5	21		50	
P080-5	1/2" M × 3/8" F	3/8" F	1/2" M	14	46.3	32	24		50	
P080-6	3/8" M × 1/2" F	1/2" F	3/8" M	11	43.8	32	24		30	

三通外X內(條) MALE / FEMALE TEE (BAR-STOCK)

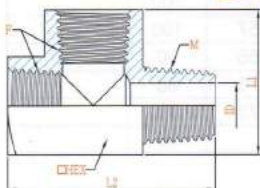

編號 ORDER NO.	規格 DIMENSION	F	M	ID	L1	L2	HEX.	牌價 PRICE	包裝 BAG	備註 NOTE
P081-0	1/8" M × 1/8" F × 1/8" F	1/8" F	1/8" M	5.5	20.5	31	14.3	45	50	
P081	1/4" M × 1/4" F × 1/4" F	1/4" F	1/4" M	8	25.8	37	17.5	56	30	
P082	3/8" M × 3/8" F × 3/8" F	3/8" F	3/8" M	11	32	46.9	20.5	92	30	
P082-1	1/2" M × 1/2" F × 1/2" F	1/2" F	1/2" M						10	訂製品 Custom-Made

※本頁庫存品皆為PT牙，如需NPT牙、特殊牙需訂製。訂購量以包裝為準，不需賣。
※線圖尺寸僅供參考，詳細尺寸以現品為準。

銅直接頭鍛造彎頭

BRASS JOINT AND FORGED BEND



代號：H：叉心 / M：外牙 / F：內牙 / S：喇叭口 / U：PU管

三通外X內(鍛)

MALE / FEMALE TEE
(FORGED BODY)

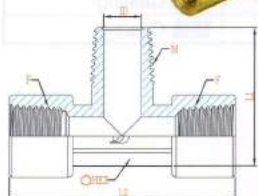

編號 ORDER NO.	規格 DIMENSION	F	M	ID	L1	L2	HEX.	牌價 PRICE	包裝 BAG	備註 NOTE
P083	1/8"M×1/8"F×1/8"F	1/8"F	1/8"M	5.5	27.7	48	11.5	58	50	
P084	1/4"M×1/4"F×1/4"F	1/4"F	1/4"M	8	30	51.5	12.5	80	50	
P085	3/8"M×3/8"F×3/8"F	3/8"F	3/8"M	11	33.9	62.3	15.5	124	30	
P086	1/2"M×1/2"F×1/2"F	1/2"F	1/2"M						30	訂製品

外牙三通

MALE TEE

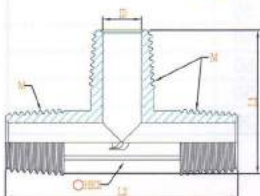

編號 ORDER NO.	規格 DIMENSION	M	ID	L1	L2	HEX.	牌價 PRICE	包裝 BAG	備註 NOTE
P087	1/8"M×1/8"M×1/8"M	1/8"M	5.5	24.3	38	9.5	40	50	
P088	1/4"M×1/4"M×1/4"M	1/4"M	8	29.5	48	11.5	58	50	
P089	3/8"M×3/8"M×3/8"M	3/8"M	11	30.6	48.8	12.5	81	30	
P090	1/2"M×1/2"M×1/2"M	1/2"M	14	36.9	60.3	15.5	122	20	
P090-1	3/4"M×3/4"M×3/4"M	3/4"M	19.1	46.1	68	21		10	

三頭內牙

FEMALE TEE

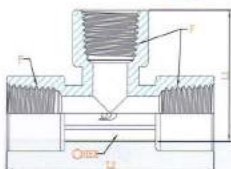

編號 ORDER NO.	規格 DIMENSION	F	L1	L2	HEX.	牌價 PRICE	包裝 BAG	備註 NOTE
P091	T1/8"F×1/8"F×1/8"F	1/8"F	29.5	48	11.5	61	50	
P092	T1/4"F×1/4"F×1/4"F	1/4"F	31.8	51.5	12.5	82	50	
P093	T3/8"F×3/8"F×3/8"F	3/8"F	37.9	62.3	15.5	127	20	

三頭內牙(鑄造)

FEMALE TEE

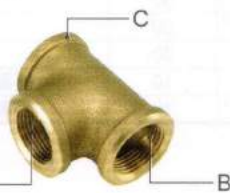

編號 ORDER NO.	規格 DIMENSION	A	B	C	牌價 PRICE	包裝 BAG	備註 NOTE
P094	T1/2"F X 1/2"F X 1/2"F	1/2"F	1/2"F	1/2"F	90	10	鑄造 Casting
P095	T3/4"F X 3/4"F X 3/4"F	3/4"F	3/4"F	3/4"F	150	10	鑄造 Casting
P096	T1"F X 1"F X 1"F	1"F	1"F	1"F	250	10	鑄造 Casting

90°雙內

DOUBLE FEMALE ELBOW

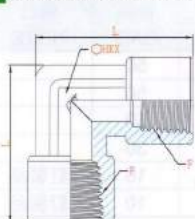

編號 ORDER NO.	規格 DIMENSION	F	L	HEX.	牌價 PRICE	包裝 BAG	備註 NOTE
P097	L1/8"F×1/8"F	1/8"F	29.7	10	43	50	
P098	L1/4"F×1/4"F	1/4"F	34.1	13	61	50	
P099	L3/8"F×3/8"F	3/8"F	37.4	14	98	30	

※本頁庫存品皆為PT牙，如需NPT牙、特殊牙需訂製。訂購量以包裝為準，不零售。

※線圖尺寸僅供參考，詳細尺寸以現品為準。



銅直接頭鍛造彎頭 BRASS JOINT AND FORGED BEND

代號：H：叉心 / M：外牙 / F：內牙 / S：喇叭口 / U：PU管

90°雙內(鑄造) DOUBLE FEMALE ELBOW (CASTING)



編號 ORDER NO.	規格 DIMENSION	A	B	牌價 PRICE	包裝 BAG	備註 NOTE
P100	L1/2"F X 1/2"F	1/2"F	1/2"F	75	20	鑄造 Casting
P101	L3/4"F X 3/4"F	3/4"F	3/4"F	120	10	鑄造 Casting
P101-1A	L1"F X 1"F	1"F	1"F		10	鑄造 Casting

90°內X外 90° FEMALE / MALE STREET ELBOW

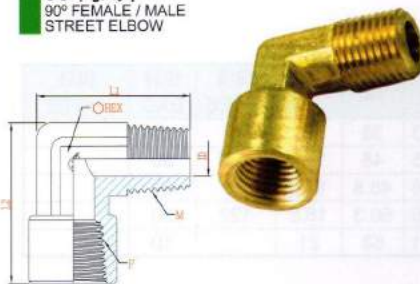

編號 ORDER NO.	規格 DIMENSION	F	M	ID	L1	L2	HEX.	牌價 PRICE	包裝 BAG	備註 NOTE
P102	1/8"F X 1/8"M	1/8"F	1/8"M	5.5	27.5	29.5	10	35	50	
P103	1/4"F X 1/8"M	1/4"F	1/8"M	5.5	29.5	32.1	11	46	50	
P103-1A	1/8"F X 1/4"M	1/8"F	1/4"M	8.5	30	29.5	10	50	50	
P104	1/4"F X 1/4"M	1/4"F	1/4"M	7.5	31.5	32.1	11	50	50	
P105	3/8"F X 1/4"M	3/8"F	1/4"M	8	33.2	36	13	65	50	
P105-1	1/4"F X 3/8"M	1/4"F	3/8"M	11	32.5	33.5	13	91	50	
P106	3/8"F X 3/8"M	3/8"F	3/8"M	11	33	35	13	91	50	
P106-0	3/8"F X 1/2"M	3/8"F	1/2"M	14	36.4	37.4	14		30	

內外彎頭(鑄造) FEMALE / MALE ELBOW (CASTING)



編號 ORDER NO.	規格 DIMENSION	A	B	牌價 PRICE	包裝 BAG	備註 NOTE
P106-1	1/2"F X 1/2"M	1/2"M	1/2"F	75	30	鑄造 Casting
P106-2	3/4"F X 3/4"M	3/4"M	3/4"F	120	20	鑄造 Casting

90°雙內牙(加強型) FEMALE ELBOW (FORTIFIED)

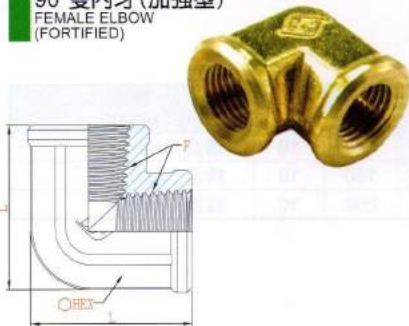

編號 ORDER NO.	規格 DIMENSION	F	L	HEX.	牌價 PRICE	包裝 BAG	備註 NOTE
P107	1/8"F X 1/8"F	1/8"F	22	13.5	37	50	
P108	1/4"F X 1/4"F	1/4"F	26.5	17	56	50	
P109	3/8"F X 3/8"F	3/8"F	31	20.5	79	50	
P109-1	1/2"F X 1/2"F	1/2"F	36.5	24		30	
P109-1-A	3/4"F X 3/4"F	3/4"F	45	30		10	訂製品
P109-1-B	1"F X 1"F	1"F	53	37		10	訂製品

三通內牙(加強型) FEMALE TEE (FORTIFIED)



編號 ORDER NO.	規格 DIMENSION	F	L1	L2	HEX.	牌價 PRICE	包裝 BAG	備註 NOTE
P110	1/8"F X 1/8"F X 1/8"F	1/8"F	22	28.5	13.7	49	50	
P111	1/4"F X 1/4"F X 1/4"F	1/4"F	27	34	17	73	50	
P112	3/8"F X 3/8"F X 3/8"F	3/8"F	29.5	37	20.5	104	50	
P113	1/2"F X 1/2"F X 1/2"F	1/2"F	38.5	50.5	25.5	196	30	
P113-1	3/4"F X 3/4"F X 3/4"F	3/4"F	45.5	57.5	30		10	訂製品
P113-2	1"F X 1"F X 1"F	1"F	54	65.5	37		10	訂製品

※本頁庫存品皆為PT牙，如需NPT牙、特殊牙需訂製。訂購量以包裝為準，不零售。
※線圖尺寸僅供參考，詳細尺寸以現品為準。

銅直接頭鍛造彎頭

BRASS JOINT AND FORGED BEND



代號：H：叉心 / M：外牙 / F：內牙 / S：喇叭口 / U：PU管

切料三通

FEMALE TEE

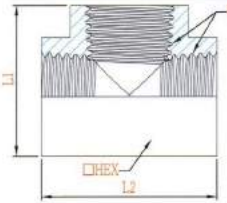
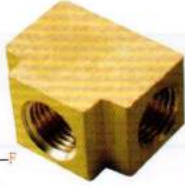

編號 ORDER NO.	規格 DIMENSION	F	L1	L2	HEX.	牌價 PRICE	包裝 BAG	備註 NOTE
P114	1/8" F × 1/8" F × 1/8" F	1/8" F	21	29.5	14	39	50	
P115	1/4" F × 1/4" F × 1/4" F	1/4" F	23	28.5	17.5	47	50	
P116	3/8" F × 3/8" F × 3/8" F	3/8" F	30	40	20.5	81	50	
P116-1	1/2" F × 1/2" F × 1/2" F	1/2" F	40.7	55.6	25.4		25	訂製品

切料十字通

FEMALE CROSS TYPE

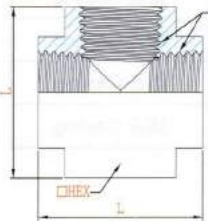

編號 ORDER NO.	規格 DIMENSION	F	L	HEX.	牌價 PRICE	包裝 BAG	備註 NOTE
P117	1/8" F	1/8" F	28.5	14	47	50	
P118	1/4" F	1/4" F	30	19	65	50	
P119	3/8" F	3/8" F	40	20.5	96	30	
P119-1	1/2" F	1/2" F	55.2	25.4		10	訂製品

高壓軟管接頭

HIGH-HANDED HOSE



編號 ORDER NO.	規格 DIMENSION	A	B	牌價 PRICE	包裝 BAG	備註 NOTE
P120	7.5m/m X 7.5m/m蝶式	7.5m/m	7.5m/m	35	50	
P121	8.5m/m X 8.5m/m蝶式	8.5m/m	8.5m/m	40	50	
P120-1	7.5m/m X 7.5m/m六角式	7.5m/m	7.5m/m		50	
P121-1	8.5m/m X 8.5m/m六角式	8.5m/m	8.5m/m		50	

切料四通

FEMALE FOUR

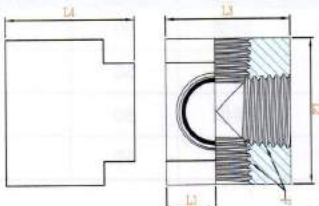

編號 ORDER NO.	規格 DIMENSION	F	L1	L2	L3	L4	牌價 PRICE	包裝 BAG	備註 NOTE
P122	1/4" F	1/4" F	10	28.5	24	23	74	50	

※本頁庫存品皆為PT牙，如需NPT牙、特殊牙需訂製。訂購量以包裝為準，不零售。
 ※線圖尺寸僅供參考，詳細尺寸以現品為準。



銅直接頭鍛造彎頭 BRASS JOINT AND FORGED BEND

代號：H：叉心 / M：外牙 / F：內牙 / S：喇叭口 / U：PU管

切料五通 BARSTOCK FIVE PORT



編號 ORDER NO.	規格 DIMENSION	F	L1	L2	牌價 PRICE	包裝 BAG	備註 NOTE
P123	1/4"	1/4"F	28.5	23	87	50	

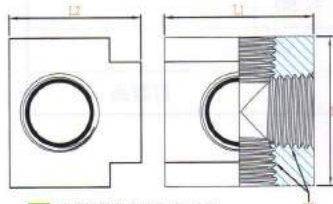

異徑雙內牙 (SB) DOUBLE FEMALE REDUCER



編號 ORDER NO.	規格 DIMENSION	A	B	牌價 PRICE	包裝 BAG	備註 NOTE
P-124	1/2"F	1/2"F		24		鑄造 Casting
P-125	3/4"F	3/4"F		38		鑄造 Casting
P-126	1"F	1"F		64		鑄造 Casting
	3/4" X 1/2"F(RSB)	3/4"	1/2"F	40		鑄造 Casting

切料四角-異徑 BARSTOCK FOUR-PORT REDUCER



編號 ORDER NO.	規格 DIMENSION	A	牌價 PRICE	包裝 BAG	備註 NOTE
⊙P-127	1/4"F	1/4"F	30		訂製品

※本產品可另外製造

十字通 FEMALE CROSS TYPE

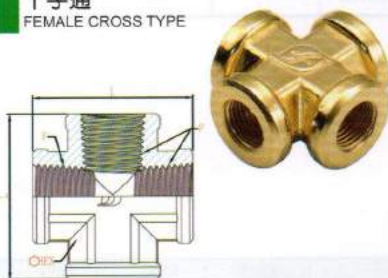

編號 ORDER NO.	規格 DIMENSION	F	L	HEX.	牌價 PRICE	包裝 BAG	備註 NOTE
P130	1/8"F	1/8"F	27	13.5		50	訂製品
P131	1/4"F	1/4"F	34	17		50	訂製品
P132	3/8"F	3/8"F	37	20		30	訂製品
P133	1/2"F	1/2"F	49	24		20	訂製品

分水接頭 WATER FILTER CONNECTOR

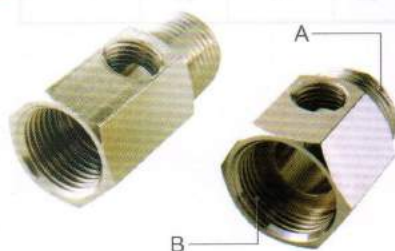

編號 ORDER NO.	規格 DIMENSION	A	B	牌價 PRICE	包裝 BAG	備註 NOTE
W09-3	1/2"有孔(一般)	1/2"M	1/2"F	時價	50	
W09-4	1/2"無孔(一般)	1/2"M	1/2"F	時價	50	
W08-2	3/4"有孔(一般)	3/4"M	3/4"F	時價	50	
W08-3	3/4"無孔(一般)	3/4"M	3/4"F	時價	50	

※本頁庫存品皆為PT牙，如需NPT牙、特殊牙需訂製。訂購量以包裝為準，不零售。
※線圖尺寸僅供參考，詳細尺寸以現品為準。

PU,PF尼龍管接頭

PU,PF NYLON TUBES FAST BRASS CONNECTOR

代號：H：叉心 / M：外牙 / F：內牙 / S：喇叭口 / U：PU管

雙頭PU

DOUBLE HEAD PU



英制 INCH

編號 ORDER NO.	規格 DIMENSION	M	ID1	OD	L	HEX.	ID2	牌價 PRICE	包裝 BOX	備註 NOTE
A-001	U1/4"U×1/4"U	M10x1.0	3	5.5	30	10	6.5	28	100	
A-002	U5/16"U×5/16"U	7/16-24	4.5	7.1	32	11	8.1	35	50	
A-003	U3/8"U×3/8"U	1/2-24	5.5	8.1	32	13	9.7	40	50	
A-004	U1/2"U×1/2"U	M17x1.0	7	11	33	17	12.9	58	50	

公制 METRIC

編號 ORDER NO.	規格 DIMENSION	M	ID1	OD	L	HEX.	ID2	牌價 PRICE	包裝 BOX	備註 NOTE
A-001-6MM	U6mmU	M10x1.0	3	5.5	30	10	6.15		100	訂製品
A-002-8MM	U8mmU	7/16-24	4.5	7.1	32	11	8.1		50	同5/16
A-003-10MM	U10mmU	1/2-24	5.5	8.1	32	13	10.2		50	
A-004-12MM	U12mmU	M17x1.0	7	10.3	33	17	12.2		50	



90°雙頭PU

90° DOUBLE HEAD PU



英制 INCH

編號 ORDER NO.	規格 DIMENSION	M	ID1	OD	L	HEX.	ID2	牌價 PRICE	包裝 BOX	備註 NOTE
A-005	L1/4"U×1/4"U	M10x1.0	3	5.5	27.3	9.5	6.5	46	50	
A-006	L5/16"U×5/16"U	7/16-24	4.5	7.1	27.3	9.5	8.1	52	50	
A-007	L3/8"U×3/8"U	1/2-24	5.5	8.1	31.5	10	9.7	70	50	
A-008	L1/2"U×1/2"U	M17x1.0	7.2	11	34.2	13	12.9	88	50	

公制 METRIC

編號 ORDER NO.	規格 DIMENSION	M	ID1	OD	L	HEX.	ID2	牌價 PRICE	包裝 BOX	備註 NOTE
A-005-6MM	L6mmU	M10x1.0	3	5.5	27.3	9.5	6.15		50	訂製品
A-006-8MM	L8mmU	7/16-24	4.5	7.1	27.3	9.5	8.1		50	同5/16
A-007-10MM	L10mmU	1/2-24	5.5	8.1	31.5	10	10.2		50	
A-008-12MM	L12mmU	M17x1.0	6.5	10.3	34.2	13	12.2		50	

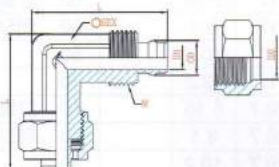

TPU三頭PU

THREE HEAD PU



英制 INCH

編號 ORDER NO.	規格 DIMENSION	M	ID1	OD	L1	L2	HEX.	ID2	牌價 PRICE	包裝 BOX	備註 NOTE
A-009	T1/4"U×1/4"U×1/4"U	M10x1.0	3	5.5	24.6	38.8	9.5	6.5	64	50	
A-010	T5/16"U×5/16"U×5/16"U	7/16-24	4.5	7.1	26.2	42.3	10	8.1	72	50	
A-011	T3/8"U×3/8"U×3/8"U	1/2-24	5.5	8.1	30.5	50.4	11.5	9.7	94	50	
A-012	T1/2"U×1/2"U×1/2"U	M17x1.0	7.2	11	31.5	51.4	12.5	12.9	127	30	

公制 METRIC

編號 ORDER NO.	規格 DIMENSION	M	ID1	OD	L1	L2	HEX.	ID2	牌價 PRICE	包裝 BOX	備註 NOTE
A-009-6MM	T6mmU	M10x1.0	3	5.5	24.6	38.8	9.5	6.15		50	訂製品
A-010-8MM	T8mmU	7/16-24	4.5	7.1	26.2	42.3	10	8.1		50	同5/16
A-011-10MM	T10mmU	1/2-24	5.5	8.1	30.5	50.4	11.5	10.2		50	
A-012-12MM	T12mmU	M17x1.0	6.5	10.3	31.5	51.4	12.5	12.2		30	

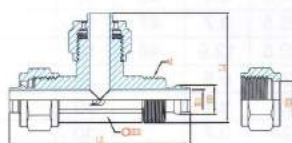

※ 訂購量以包裝為準，不零售。
※ 線圖尺寸僅供參考，詳細尺寸以現品為準。

PU.PF尼龍管接頭

PU.PF NYLON TUBES. FAST BRASS CONNECTOR

代號：H：叉心 / M：外牙 / F：內牙 / S：喇叭口 / U：PU管

PU外牙直接頭 MALE PU HEAD

英制 INCH

編號 ORDER NO.	規格 DIMENSION	M1	M2	ID1	OD	L	HEX.	ID2	牌價 PRICE	包裝 BOX	備註 NOTE
A-013	1/8" M × 1/4" U	M10x1.0	1/8" M	3	5.5	25.5	10	6.5	20	100	
A-014-1	1/8" M × 5/16" U	7/16-24	1/8" M	4.5	7.1	26.5	11	8.1	24	100	
A-014-2	1/8" M × 3/8" U	1/2-24	1/8" M	5.5	8.1	26.5	13	9.7	28	100	
A-014	1/4" M × 1/4" U	M10x1.0	1/4" M	3	5.5	27.5	14	6.5	26	100	
A-015	1/4" M × 5/16" U	7/16-24	1/4" M	4.5	7.1	28.5	14	8.1	29	100	
A-016	1/4" M × 3/8" U	1/2-24	1/4" M	5.5	8.1	28.5	14	9.7	29	50	
A-016-1	1/4" M × 1/2" U	M17x1.0	1/4" M	7	11	29	17	12.9	40	50	
A-017-1	3/8" M × 1/4" U	M10x1.0	3/8" M	3	5.5	28.5	17	6.5	32	50	
A-017-2	3/8" M × 5/16" U	7/16-24	3/8" M	4.5	7.1	29.5	17	8.1	35	50	
A-017	3/8" M × 3/8" U	1/2-24	3/8" M	5.5	8.1	29.5	17	9.7	36	50	
A-018	3/8" M × 1/2" U	M17x1.0	3/8" M	7	11	30	17	12.9	40	50	
A-019-1	1/2" M × 1/4" U	M10x1.0	1/2" M	3	5.5	30.5	20.7	6.5	42	50	
A-019-2	1/2" M × 5/16" U	7/16-24	1/2" M	4.5	7.1	31.5	20.7	8.1	46	50	
A-019-3	1/2" M × 3/8" U	1/2-24	1/2" M	5.5	8.1	31.5	20.7	9.7	47	50	
A-019-4	1/2" M × 1/2" U	M17x1.0	1/2" M	7	11	32	20.7	12.9	51	50	
A-013-1	1/8" M × 4U	M7x1.0	1/8" M	1.8	3.8	22.8	10	4.15		100	

公制 METRIC

編號 ORDER NO.	規格 DIMENSION	M1	M2	ID1	OD	L	HEX.	ID2	牌價 PRICE	包裝 BOX	備註 NOTE
A-013-6MM	1/8" M × 6U	M10x1.0	1/8" M	3	5.5	25.5	10	6.15		100	
A-014-1-8MM	1/8" M × 8U	7/16-24	1/8" M	4.5	7.1	26.5	11	8.1		100	同5/16
A-014-2-10MM	1/8" M × 10U	1/2-24	1/8" M	5.5	8.1	26.5	13	10.2		100	
A-014-6MM	1/4" M × 6U	M10x1.0	1/4" M	3	5.5	27.5	14	6.15		100	
A-015-8MM	1/4" M × 8U	7/16-24	1/4" M	4.5	7.1	28.5	14	8.1		100	同5/16
A-016-10MM	1/4" M × 10U	1/2-24	1/4" M	5.5	8.1	28.5	14	10.2		50	
A-016-1-12MM	1/4" M × 12U	M17x1.0	1/4" M	7	10.3	29	17	12.2		50	
A-017-1-6MM	3/8" M × 6U	M10x1.0	3/8" M	3	5.5	28.5	17	6.15		50	訂製品
A-017-2-8MM	3/8" M × 8U	7/16-24	3/8" M	4.5	7.1	29.5	17	8.1		50	同5/16
A-017-10MM	3/8" M × 10U	1/2-24	3/8" M	5.5	8.1	29.5	17	10.2		50	
A-018-12MM	3/8" M × 12U	M17x1.0	3/8" M	7	10.3	30	17	12.2		50	
A-019-1-6MM	1/2" M × 6U	M10x1.0	1/2" M	3	5.5	30.5	20.7	6.15		50	訂製品
A-019-2-8MM	1/2" M × 8U	7/16-24	1/2" M	4.5	7.1	31.5	20.7	8.1		50	同5/16
A-019-3-10MM	1/2" M × 10U	1/2-24	1/2" M	5.5	8.1	31.5	20.7	10.2		50	
A-019-4-12MM	1/2" M × 12U	M17x1.0	1/2" M	7	10.3	32	20.7	12.2		50	

PU內牙直接頭 FEMALE PU HEAD

英制 INCH

編號 ORDER NO.	規格 DIMENSION	M	F	ID1	OD	L	HEX.	ID2	牌價 PRICE	包裝 BOX	備註 NOTE
A-020	1/8" F × 1/4" U	M10x1.0	1/8" F	3	5.5	24.5	12	6.5	22	100	
A-020-1	1/8" F × 5/16" U	7/16-24	1/8" F	4.5	7.1	25.5	12	8.1		100	
A-020-2	1/8" F × 3/8" U	1/2-24	1/8" F	5.5	8.1	25.5	13	9.7		50	
A-020-3	1/8" F × 1/2" U	M17x1.0	1/8" F							50	訂製品
A-021	1/4" F × 1/4" U	M10x1.0	1/4" F	3	5.5	27.5	17	6.5	32	100	
A-022	1/4" F × 5/16" U	7/16-24	1/4" F	4.5	7.1	28.5	17	8.1	36	50	
A-023	1/4" F × 3/8" U	1/2-24	1/4" F	5.5	8.1	28.5	17	9.7	37	50	
A-023-1	1/4" F × 1/2" U	M17x1.0	1/4" F	7	11	29	17	12.9		50	訂製品
A-024-1	3/8" F × 1/4" U	M10x1.0	3/8" F	3	5.5	27.5	20.5	6.5	41	50	
A-024-2	3/8" F × 5/16" U	7/16-24	3/8" F	4.5	7.1	28.5	20.5	8.1	43	50	
A-024	3/8" F × 3/8" U	1/2-24	3/8" F	5.5	8.1	28.5	20.5	9.7	47	50	
A-025	3/8" F × 1/2" U	M17x1.0	3/8" F	7	11	29	20.5	12.9	48	50	
A-025-1	1/2" F × 1/4" U	M10x1.0	1/2" F	3	5.5	30	24	6.5		30	
A-025-2	1/2" F × 5/16" U	7/16-24	1/2" F	4.5	7.1	31	24	8.1		30	
A-025-3	1/2" F × 3/8" U	1/2-24	1/2" F	5.5	8.1	31	24	9.7		30	
A-025-4	1/2" F × 1/2" U	M17x1.0	1/2" F	7	11	31.5	24	12.9		30	

*本頁可訂製 6, 8, 10, 12mm 必須告知。

*本頁庫存品皆為PT牙，如需NPT牙、特殊牙需訂製。訂購量以包裝為準，不需費。

PU,PF尼龍管接頭

PU,PF NYLON TUBES, FAST BRASS CONNECTOR

代號：H：叉心 / M：外牙 / F：內牙 / S：喇叭口 / U：PU管

PU內牙直接頭 FEMALE PU HEAD



公制METRIC

編號 ORDER NO.	規格 DIMENSION	M	F	ID1	OD	L	HEX.	ID2	牌價 PRICE	包裝 BOX	備註 NOTE
A-020-6MM	1/8"F×6U	M10x1.0	1/8"F	3	5.5	24.5	12	6.15		100	
A-020-1-8MM	1/8"F×8U	7/16-24	1/8"F	4.5	7.1	25.5	12	8.1		100	同5/16
A-020-2-10MM	1/8"F×10U	1/2-24	1/8"F	5.5	8.1	25.5	13	10.2		50	
A-020-3-12MM	1/8"F×12U	M17x1.0	1/8"F							50	訂製品
A-021-6MM	1/4"F×6U	M10x1.0	1/4"F	3	5.5	27.5	17	6.15		100	
A-022-8MM	1/4"F×8U	7/16-24	1/4"F	4.5	7.1	28.5	17	8.1		50	同5/16
A-023-10MM	1/4"F×10U	1/2-24	1/4"F	5.5	8.1	28.5	17	10.2		50	
A-023-1-12MM	1/4"F×12U	M17x1.0	1/4"F	7	11	29	17	12.2		50	訂製品
A-024-1-6MM	3/8"F×6U	M10x1.0	3/8"F	3	4.8	26.7	20.5	6.15		50	
A-024-2-8MM	3/8"F×8U	7/16-24	3/8"F	4.5	7.1	28.5	20.5	8.1		50	同5/16
A-024-10MM	3/8"F×10U	1/2-24	3/8"F	5.5	8.1	28.5	20.5	10.2		50	
A-025-12MM	3/8"F×12U	M17x1.0	3/8"F	7	10.3	29	20.5	12.2		50	
A-025-1-6MM	1/2"F×6U	M10x1.0	1/2"F	3	5.5	30	24	6.15		30	
A-025-2-8MM	1/2"F×8U	7/16-24	1/2"F	4.5	7.1	31	24	8.1		30	同5/16
A-025-3-10MM	1/2"F×10U	1/2-24	1/2"F	5.5	8.1	31	24	10.2		30	
A-025-4-12MM	1/2"F×12U	M17x1.0	1/2"F	7	10.3	31.5	24	12.2		30	

90°內牙PU接頭 90° FEMALE PU HEAD ELBOW



英制INCH

編號 ORDER NO.	規格 DIMENSION	M	F	ID1	OD	L1	L2	HEX.	ID2	牌價 PRICE	包裝 BOX	備註 NOTE
A-026	1/8"F×1/4"U	M10x1.0	1/8"F	3	5.5	27.5	29.5	10	6.5	44	50	
A-026-1	1/8"F×5/16"U	7/16-24	1/8"F	4.5	7.1	27.5	29.5	10	8.1	46	50	
A-027	1/4"F×1/4"U	M10x1.0	1/4"F	3	5.5	29.8	32.1	11	6.5	53	50	
A-028	1/4"F×5/16"U	7/16-24	1/4"F	4.5	7.1	29.8	32.1	11	8.1	57	50	
A-029	1/4"F×3/8"U	1/2-24	1/4"F	5.5	8.1	32.2	32.1	11	9.7	63	50	
A-029-1	1/4"F×1/2"U	M17x1.0	1/4"F	7.2	11	34.2	34	13	12.9		50	
A-030-1	3/8"F×1/4"U	M10x1.0	3/8"F	3	5.5	33.8	36	13	6.5	80	50	
A-030-2	3/8"F×5/16"U	7/16-24	3/8"F	4.5	7.1	33.8	36	13	8.1	83	50	
A-030-3	3/8"F×3/8"U	1/2-24	3/8"F	5.5	8.1	34.5	36	13	9.7	74	50	
A-030	3/8"F×1/2"U	M17x1.0	3/8"F	7.2	11	34.2	36	13	12.9	85	50	

公制METRIC

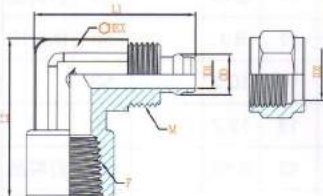

編號 ORDER NO.	規格 DIMENSION	M	F	ID1	OD	L1	L2	HEX.	ID2	牌價 PRICE	包裝 BOX	備註 NOTE
A-026-6MM	1/8"F×6U	M10x1.0	1/8"F	3	5.5	27.5	29.5	10	6.15		50	訂製品
A-026-1-8MM	1/8"F×8U	7/16-24	1/8"F	4.5	7.1	27.5	29.5	10	8.1		50	同5/16
A-027-6MM	1/4"F×6U	M10x1.0	1/4"F	3	5.5	29.8	32.1	11	6.15		50	訂製品
A-028-8MM	1/4"F×8U	7/16-24	1/4"F	4.5	7.1	29.8	32.1	11	8.1		50	同5/16
A-029-10MM	1/4"F×10U	1/2-24	1/4"F	5.5	8.1	32.2	32.1	11	10.2		50	
A-029-1-12MM	1/4"F×12U	M17x1.0	1/4"F	6.5	10.3	34.2	34	13	12.2		50	訂製品
A-030-1-6MM	3/8"F×6U	M10x1.0	3/8"F	3	5.5	33.8	36	13	6.15		50	訂製品
A-030-2-8MM	3/8"F×8U	7/16-24	3/8"F	4.5	7.1	33.8	36	13	8.1		50	同5/16
A-030-3-10MM	3/8"F×10U	1/2-24	3/8"F	5.5	8.1	34.5	36	13	10.2		50	
A-030-12MM	3/8"F×12U	M17x1.0	3/8"F	6.5	10.3	34.2	36	13	12.2		50	

※ 訂購量以包裝為準，不零售。

※ 線圖尺寸僅供參考，詳細尺寸以現品為準。

PU.PF尼龍管接頭 PU.PF NYLON TUBES. FAST BRASS CONNECTOR

代號：H：叉心 / M：外牙 / F：內牙 / S：喇叭口 / U：PU管

90°外牙PU接頭 90° MALE PU HEAD ELBOW

英制INCH

編號 ORDER NO.	規格 DIMENSION	M1	M2	ID1	OD	L1	L2	HEX.	ID2	牌價 PRICE	包裝 BOX	備註 NOTE
A-031	1/8" M × 1/4" U	M10x1.0	1/8" M	3	5.5	27.3	25.4	9.5	6.5	37	100	
A-032-1	1/8" M × 5/16" U	7/16-24	1/8" M	4.5	7.1	27.3	25.4	9.5	8.1	41	100	
A-032-2	1/8" M × 3/8" U	1/2-24	1/8" M	5.5	8.1	30.2	27.5	10	9.7	46	100	
A-032	1/4" M × 1/4" U	M10x1.0	1/4" M	3	5.5	27.5	30	10	6.5	42	100	
A-033	1/4" M × 5/16" U	7/16-24	1/4" M	4.5	7.1	27.5	30	10	8.1	46	50	
A-034	1/4" M × 3/8" U	1/2-24	1/4" M	5.5	8.1	31.5	30	10	9.7	50	50	
A-034-1	1/4" M × 1/2" U	M17x1.0	1/4" M	7.2	11	32.4	30.5	11	12.9	67	50	
A-035-1	3/8" M × 1/4" U	M10x1.0	3/8" M	3	5.5	29.8	30.5	11	6.5	52	50	
A-035-2	3/8" M × 5/16" U	7/16-24	3/8" M	4.5	7.1	29.8	30.5	11	8.1	56	50	
A-035	3/8" M × 3/8" U	1/2-24	3/8" M	5.5	8.1	32.2	30.5	11	9.7	60	50	
A-036-1	3/8" M × 1/2" U	M17x1.0	3/8" M	7.2	11	34.2	32.5	13	12.9	74	50	
A-036-2	1/2" M × 1/4" U	M10x1.0	1/2" M	3	5.5	33.8	36	13	6.5	72	50	
A-036-3	1/2" M × 5/16" U	7/16-24	1/2" M	4.5	7.1	33.8	36	13	8.1	76	50	
A-036-4	1/2" M × 3/8" U	1/2-24	1/2" M	5.5	8.1	34.2	36	13	9.7	74	50	
A-036	1/2" M × 1/2" U	M17x1.0	1/2" M	7.2	11	34.2	35.3	13	12.9	92	50	

公制METRIC

編號 ORDER NO.	規格 DIMENSION	M1	M2	ID1	OD	L1	L2	HEX.	ID2	牌價 PRICE	包裝 BOX	備註 NOTE
A-031-6MM	1/8" M × 6U	M10x1.0	1/8" M	3	5.5	27.3	25.4	9.5	6.15		100	
A-032-1-8MM	1/8" M × 8U	7/16-24	1/8" M	4.5	7.1	27.3	25.4	9.5	8.1		100	同5/16
A-032-2-10MM	1/8" M × 10U	1/2-24	1/8" M	5.5	8.1	30.2	27.5	10	10.2		100	
A-032-6MM	1/4" M × 6U	M10x1.0	1/4" M	3	5.5	27.5	30	10	6.15		100	
A-033-8MM	1/4" M × 8U	7/16-24	1/4" M	4.5	7.1	27.5	30	10	8.1		50	同5/16
A-034-10MM	1/4" M × 10U	1/2-24	1/4" M	5.5	8.1	31.5	30	10	10.2		50	
A-034-1-12MM	1/4" M × 12U	M17x1.0	1/4" M	6.5	10.3	32.4	30.5	11	12.2		50	
A-035-1-6MM	3/8" M × 6U	M10x1.0	3/8" M	3	5.5	29.8	30.5	11	6.15		50	訂製品
A-035-2-8MM	3/8" M × 8U	7/16-24	3/8" M	4.5	7.1	29.8	30.5	11	8.1		50	同5/16
A-035-10MM	3/8" M × 10U	1/2-24	3/8" M	5.5	8.1	32.2	30.5	11	10.2		50	
A-036-1-12MM	3/8" M × 12U	M17x1.0	3/8" M	6.5	10.3	34.2	32.5	13	12.2		50	
A-036-2-6MM	1/2" M × 6U	M10x1.0	1/2" M	3	5.5	33.8	36	13	6.15		50	訂製品
A-036-3-8MM	1/2" M × 8U	7/16-24	1/2" M	4.5	7.1	33.8	36	13	8.1		50	同5/16
A-036-4-10MM	1/2" M × 10U	1/2-24	1/2" M	5.5	8.1	34.2	36	13	10.2		50	
A-036-12MM	1/2" M × 12U	M17x1.0	1/2" M	6.5	10.3	34.2	35.3	13	12.2		50	

※本頁可訂製 6, 8, 10, 12mm 必須告知。

※本頁庫存品皆為PT牙，如需NPT牙、特殊牙需訂製。訂購量以包裝為準，不需費。

PU.PF尼龍管接頭

PU.PF NYLON TUBES FAST BRASS CONNECTOR

代號：H：叉心 / M：外牙 / F：內牙 / S：喇叭口 / U：PU管

T外牙雙頭PU T MALE DOUBLE PU HEAD TEE

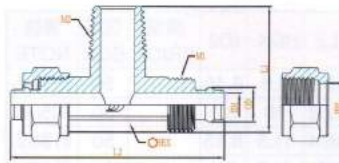

英制INCH

編號 ORDER NO.	規格 DIMENSION	M1	M2	ID1	OD	L1	L2	HEX.	ID2	牌價 PRICE	包裝 BOX	備註 NOTE
A-037	1/8" M × 1/4" U × 1/4" U	M10x1.0	1/8" M	3	5.5	24.3	38.8	9.5	6.5	56	50	
A-037-1	1/8" M × 5/16" U × 5/16" U	7/16-24	1/8" M	4.5	7.1	24.3	38.8	9.5	8.1	62	50	
A-037-2	1/8" M × 3/8" U × 3/8" U	1/2-24	1/8" M	5.5	8.1	27.7	50.4	11.5	9.7		50	
A-037-3	1/8" M × 1/2" U × 1/2" U	M17x1.0	1/8" M								50	訂製品
A-038	1/4" M × 1/4" U × 1/4" U	M10x1.0	1/4" M	3	5.5	29.2	46	11.5	6.5	74	50	
A-039	1/4" M × 5/16" U × 5/16" U	7/16-24	1/4" M	4.5	7.1	29.2	49	11.5	8.1	79	50	
A-040	1/4" M × 3/8" U × 3/8" U	1/2-24	1/4" M	5.5	8.1	29.2	50.4	11.5	9.7	81	50	
A-041-1	1/4" M × 1/2" U × 1/2" U	M17x1.0	1/4" M	7.2	11	29.7	51.4	12.5	12.9	112	50	
A-042-1A	3/8" M × 1/4" U × 1/4" U	M10x1.0	3/8" M	3	5.5	33.9	48.6	12	6.5	91	50	
A-041-2	3/8" M × 5/16" U × 5/16" U	7/16-24	3/8" M	4.5	7.1	33.9	48.8	12	8.1	97	50	
A-041	3/8" M × 3/8" U × 3/8" U	1/2-24	3/8" M	5.5	8.1	33.9	49.2	12	9.7	101	50	
A-042-1	3/8" M × 1/2" U × 1/2" U	M17x1.0	3/8" M	7.2	11	31	51.4	12.5	12.9	112	50	
A-042-2A	1/2" M × 1/4" U × 1/4" U	M10x1.0	1/2" M	3	5.5	36.9	55	13	6.5		50	
A-042-2B	1/2" M × 5/16" U × 5/16" U	7/16-24	1/2" M	4.5	7.1	36.9	55	13	8.1		50	
A-042-2	1/2" M × 3/8" U × 3/8" U	1/2-24	1/2" M	5.5	8.1	36.9	55.7	13	9.7	139	50	
A-042	1/2" M × 1/2" U × 1/2" U	M17x1.0	1/2" M	7.2	11	36.9	56.9	13	12.9	151	50	

公制METRIC

編號 ORDER NO.	規格 DIMENSION	M1	M2	ID1	OD	L1	L2	HEX.	ID2	牌價 PRICE	包裝 BOX	備註 NOTE
A-037-6MM	1/8" M × 6U × 6U	M10x1.0	1/8" M	3	5.5	24.3	38.8	9.5	6.15		50	
A-037-1-8MM	1/8" M × 8U × 8U	7/16-24	1/8" M	4.5	7.1	24.3	38.8	9.5	8.1		50	同5/16
A-037-2-10MM	1/8" M × 10U × 10U	1/2-24	1/8" M	5.5	8.1	27.7	50.4	11.5	10.2		50	
A-037-3-12MM	1/8" M × 12U × 12U	M17x1.0	1/8" M								50	訂製品
A-038-6MM	1/4" M × 6U × 6U	M10x1.0	1/4" M	3	5.5	29.2	46	11.5	6.15		50	
A-039-8MM	1/4" M × 8U × 8U	7/16-24	1/4" M	4.5	7.1	29.2	49	11.5	8.1		50	同5/16
A-040-10MM	1/4" M × 10U × 10U	1/2-24	1/4" M	5.5	8.1	29.2	50.4	11.5	10.2		50	
A-041-1-12MM	1/4" M × 12U × 12U	M17x1.0	1/4" M	6.5	10.3	29.7	51.4	12.5	12.2		50	
A-042-1A-6MM	3/8" M × 6U × 6U	M10x1.0	3/8" M	3	4.8	33.9	48.6	12	6.15		50	
A-041-2-8MM	3/8" M × 8U × 8U	7/16-24	3/8" M	4.5	7.1	33.9	48.8	12	8.1		50	同5/16
A-041-10MM	3/8" M × 10U × 10U	1/2-24	3/8" M	5.5	8.1	33.9	49.2	12	10.2		50	
A-042-1-12MM	3/8" M × 12U × 12U	M17x1.0	3/8" M	6.5	10.3	31	51.4	12.5	12.2		50	
A-042-2A-6MM	1/2" M × 6U × 6U	M10x1.0	1/2" M	3	5.5	36.9	55	13	6.15		50	訂製品
A-042-2B-8MM	1/2" M × 8U × 8U	7/16-24	1/2" M	4.5	7.1	36.9	55	13	8.1		50	同5/16
A-042-2-10MM	1/2" M × 10U × 10U	1/2-24	1/2" M	5.5	8.1	36.9	55.7	13	10.2		50	
A-042-12MM	1/2" M × 1/2U × 12U	M17x1.0	1/2" M	6.5	10.3	36.9	56.9	13	12.2		50	

※ 訂購量以包裝為準，不需費。

※ 線圖尺寸僅供參考，詳細尺寸以現品為準。

PU.PF尼龍管接頭

PU,PF NYLON TUBES. FAST BRASS CONNECTOR

代號：H：叉心 / M：外牙 / F：內牙 / S：喇叭口 / U：PU管

F外牙雙頭PU F MALE DOUBLE PU HEAD TEE

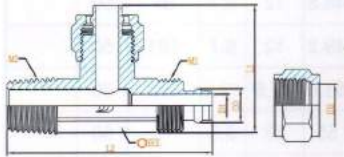

英制INCH

編號 ORDER NO.	規格 DIMENSION	M1	M2	ID1	OD	L1	L2	HEX.	ID2	牌價 PRICE	包裝 BOX	備註 NOTE
A-043	1/8" M × 1/4" U × 1/4" U	M10x1.0	1/8" M	3	5.5	24.5	38.8	9.5	6.5	56	50	
A-044-1	1/8" M × 5/16" U × 5/16" U	7/16-24	1/8" M	4.5	7.1	26.2	42.2	10	8.1	62	50	
A-044	1/4" M × 1/4" U × 1/4" U	M10x1.0	1/4" M	3	5.5	28.3	46.4	11.5	6.5	73	50	
A-045	1/4" M × 5/16" U × 5/16" U	7/16-24	1/4" M	4.5	7.1	29.8	48	11.5	8.1	79	50	
A-046	1/4" M × 3/8" U × 3/8" U	1/2-24	1/4" M	5.5	8.1	30.5	48	11.5	9.7	81	50	
A-047-1	1/4" M × 1/2" U × 1/2" U	M17x1.0	1/4" M	7.2	11	31.5	49.6	12.5	12.9	111	50	
A-047-2	3/8" M × 1/4" U × 1/4" U	M10x1.0	3/8" M	3	5.5	28.7	47.3	12	6.5	94	50	
A-047-3	3/8" M × 5/16" U × 5/16" U	7/16-24	3/8" M	4.5	7.1	30	48.8	12	8.1	97	50	
A-047	3/8" M × 3/8" U × 3/8" U	1/2-24	3/8" M	5.5	8.1	30.9	49.5	12	9.7	98	50	
A-048-1	3/8" M × 1/2" U × 1/2" U	M17x1.0	3/8" M	7.2	11	31.5	50.1	12.5	12.9	112	50	
A-048-2	1/2" M × 1/4" U × 1/4" U	M10x1.0	1/2" M	3	5.5	33.9	57.3	13	6.5		50	
A-048-3	1/2" M × 5/16" U × 5/16" U	7/16-24	1/2" M	4.5	7.1	33.9	57.3	13	8.1		50	
A-048-4	1/2" M × 3/8" U × 3/8" U	1/2-24	1/2" M	5.5	8.1	34.6	58	13	9.7		50	
A-048	1/2" M × 1/2" U × 1/2" U	M17x1.0	1/2" M	7.2	11	35.2	58.6	13	12.9		50	

公制METRIC

編號 ORDER NO.	規格 DIMENSION	M1	M2	ID1	OD	L1	L2	HEX.	ID2	牌價 PRICE	包裝 BOX	備註 NOTE
A-043-6MM	1/8" M × 6U × 6U	M10x1.0	1/8" M	3	5.5	24.5	38.8	9.5	6.15		50	訂製品
A-044-1-8MM	1/8" M × 8U × 8U	7/16-24	1/8" M	4.5	7.1	26.2	42.2	10	8.1		50	同5/16
A-044-1-6MM	1/4" M × 6U × 6U	M10x1.0	1/4" M	3	5.5	28.3	46.4	11.5	6.15		50	訂製品
A-045-8MM	1/4" M × 8U × 8U	7/16-24	1/4" M	4.5	7.1	29.8	48	11.5	8.1		50	同5/16
A-046-10MM	1/4" M × 10U × 10U	1/2-24	1/4" M	5.5	8.1	30.5	48	11.5	10.2		50	
A-047-1-12MM	1/4" M × 1/2U × 1/2U	M17x1.0	1/4" M	6.5	10.3	31.5	49.6	12.5	12.2		50	
A-047-2-6MM	3/8" M × 6U × 6U	M10x1.0	3/8" M	3	5.5	28.7	47.3	12	6.15		50	訂製品
A-047-3-8MM	3/8" M × 8U × 8U	7/16-24	3/8" M	4.5	7.1	30	48.8	12	8.1		50	同5/16
A-047-10MM	3/8" M × 10U × 10U	1/2-24	3/8" M	5.5	8.1	30.9	49.5	12	10.2		50	
A-048-1-12MM	3/8" M × 1/2U × 1/2U	M17x1.0	3/8" M	6.5	10.3	31.5	50.1	12.5	12.2		50	
A-048-2-6MM	1/2" M × 6U × 6U	M10x1.0	1/2" M	3	5.5	33.9	57.3	13	6.15		50	訂製品
A-048-3-8MM	1/2" M × 8U × 8U	7/16-24	1/2" M	4.5	7.1	33.9	57.3	13	8.1		50	同5/16
A-048-4-10MM	1/2" M × 10U × 10U	1/2-24	1/2" M	5.5	8.1	34.6	58	13	10.2		50	
A-048-12MM	1/2" M × 1/2U × 1/2U	M17x1.0	1/2" M	6.5	10.3	35.2	58.6	13	12.2		50	

PU六角 HEX NUT

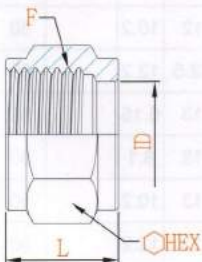

英制INCH

編號 ORDER NO.	規格 DIMENSION	F	ID	L	HEX.	牌價 PRICE	包裝 BOX	備註 NOTE
A-049	1/4" U	M10x1.0	6.5	10	12	6		
A-050	5/16" U	7/16-24	8.1	11	14	9		
A-051	3/8" U	1/2-24	9.7	11	15	9		
A-051-1	1/2" U	M17x1.0	12.9	12	19			

公制METRIC

編號 ORDER NO.	規格 DIMENSION	F	ID	L	HEX.	牌價 PRICE	包裝 BOX	備註 NOTE
A-052	6mm U	M10x1.0	6.15	10	12			
A-053	8mm U	7/16-24	8.1	11	14			同5/16
A-054	10mm U	1/2-24	10.2	11	15			
A-055	12mm U	M17x1.0	12.2	12	19			

※本頁可訂製 6, 8, 10, 12mm 必須告知。

※本頁庫存品皆為PT牙，如需NPT牙、特殊牙需訂製。訂購量以包裝為準，不零售。

PU/PF尼龍管接頭(實用型)

PU/PF NYLON TUBES. FAST BRASS CONNECTOR

代號：H：叉心 / M：外牙 / F：內牙 / S：喇叭口 / U：PU管

雙頭PU(實用型)

DOUBLE HEAD PU (APPLIED)



英制 INCH

編號 ORDER NO.	規格 DIMENSION	M	ID1	OD	L	HEX.	ID2	包裝 BOX	備註 NOTE
MINI-A-001	U1/4"U×1/4"U	M10x1.0	3	5.5	30	10	6.5	100	訂製品
MINI-A-002	U5/16"U×5/16"U	7/16-24	4.2	7.1	32	11	8.1	50	訂製品
MINI-A-003	U3/8"U×3/8"U	1/2-24	5.2	8.1	32	13	9.7	50	訂製品
MINI-A-004	U1/2"U×1/2"U	M17x1.0	7	11	33	17	12.9	50	訂製品

TPU三通PU(實用型)

THREE HEAD PU TEE (APPLIED)

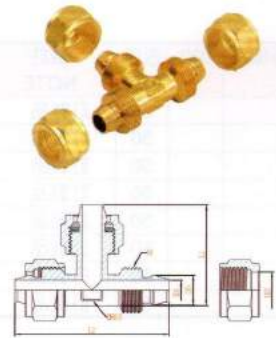

英制 INCH

編號 ORDER NO.	規格 DIMENSION	M	ID1	OD	L1	L2	HEX.	ID2	包裝 BOX	備註 NOTE
MINI-A-009	T1/4"U×1/4"U×1/4"U	M10x1.0	3	5.5	24.6	38.8	9.5	6.5	50	訂製品
MINI-A-010	T5/16"U×5/16"U×5/16"U	7/16-24	4.5	7.1	26.2	42.3	10	8.1	50	訂製品
MINI-A-011	T3/8"U×3/8"U×3/8"U	1/2-24	5.5	8.1	30.5	50.4	11.5	9.7	50	訂製品
MINI-A-012	T1/2"U×1/2"U×1/2"U	M17x1.0	7.2	11	31.5	51.4	12.5	12.9	30	訂製品

PU外牙直接頭(實用型)

MALE PU HEAD (APPLIED)



英制 INCH

編號 ORDER NO.	規格 DIMENSION	M1	M2	ID1	OD	L	HEX.	ID2	包裝 BOX	備註 NOTE
MINI-A-013	1/8"M×1/4"U	M10x1.0	1/8"M	3	5.5	25.5	10	6.5	100	訂製品
MINI-A-014-1	1/8"M×5/16"U	7/16-24	1/8"M	4.5	7.1	26.5	11	8.1	100	訂製品
MINI-A-014-2	1/8"M×3/8"U	1/2-24	1/8"M	5.5	8.1	26.5	13	9.7	100	訂製品
MINI-A-014	1/4"M×1/4"U	M10x1.0	1/4"M	3	5.5	27.5	14	6.5	100	訂製品
MINI-A-015	1/4"M×5/16"U	7/16-24	1/4"M	4.5	7.1	28.5	14	8.1	100	訂製品
MINI-A-016	1/4"M×3/8"U	1/2-24	1/4"M	5.5	8.1	28.5	14	9.7	50	訂製品
MINI-A-016-1	1/4"M×1/2"U	M17x1.0	1/4"M	7	11	29	17	12.9	50	訂製品
MINI-A-017-1	3/8"M×1/4"U	M10x1.0	3/8"M	3	5.5	28.5	17	6.5	50	訂製品
MINI-A-017-2	3/8"M×5/16"U	7/16-24	3/8"M	4.5	7.1	29.5	17	8.1	50	訂製品
MINI-A-017	3/8"M×3/8"U	1/2-24	3/8"M	5.5	8.1	29.5	17	9.7	50	訂製品
MINI-A-018	3/8"M×1/2"U	M17x1.0	3/8"M	7	11	30	17	12.9	50	訂製品
MINI-A-019-1	1/2"M×1/4"U	M10x1.0	1/2"M	3	5.5	30.5	20.7	6.5	50	訂製品
MINI-A-019-2	1/2"M×5/16"U	7/16-24	1/2"M	4.5	7.1	31.5	20.7	8.1	50	訂製品
MINI-A-019-3	1/2"M×3/8"U	1/2-24	1/2"M	5.5	8.1	31.5	20.7	9.7	50	訂製品
MINI-A-019-4	1/2"M×1/2"U	M17x1.0	1/2"M	7	11	32	20.7	12.9	50	訂製品

※ 訂購量以包裝為準，不需費。

※ 線圖尺寸僅供參考，詳細尺寸以現品為準。

喇叭口銅管接頭 TRUMPET BRASS CONNECTOR FOR BRASS TUBE

代號：H：叉心 / M：外牙 / F：內牙 / S：喇叭口 / U：PU管



喇叭螺母 TRUMPET NUT

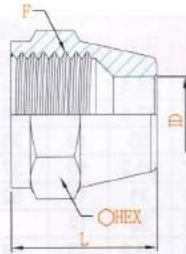

英制INCH

編號 ORDER NO.	規格 DIMENSION	F	ID	L	HEX.	牌價 PRICE	包裝 BAG	備註 NOTE
C-001	1/4"	7/16-20	6.5	13.5	14	10	200	
C-002	5/16"	1/2-20	8.1	15	16	12	200	
C-003	3/8"	5/8-18	9.8	19	19	19	100	
C-004	1/2"	3/4-16	13	22	23	31	50	
C-004-1	5/8"	7/8-14	16.2	21	27		30	
C-004-2	3/4"	1 1/16-14	19.3	24	32		20	

喇叭螺母(小頭專用) TRUMPET NUT

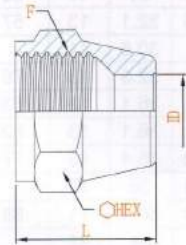

英制INCH

編號 ORDER NO.	規格 DIMENSION	F	ID	L	HEX.	牌價 PRICE	包裝 BAG	備註 NOTE
C-003-1	3/8"	9/16-18	9.8	17	19		100	

平喇叭六角 NUT

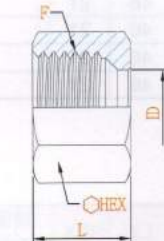
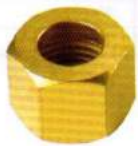

英制INCH

編號 ORDER NO.	規格 DIMENSION	F	ID	L	HEX.	牌價 PRICE	包裝 BAG	備註 NOTE
C-005	1/4"	7/16-20	6.5	12	14	10	200	
C-006	5/16"	1/2-20	8.5	13	17	16	100	
C-007	3/8"	9/16-18	9.8	12.8	17	14	100	小頭專用
C-008	1/2"	3/4-16	13	17	23	29	50	

公牙直接頭 MALE CONNECTOR

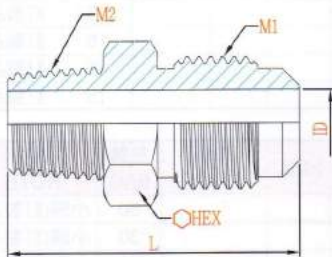

編號 ORDER NO.	規格 DIMENSION	M1	M2	ID	L	HEX.	牌價 PRICE	包裝 BAG	備註 NOTE
C-009-1	1/8"M×5/16"S	1/2-20	1/8"M	6	30	14	20	100	
C-009	1/8"M×1/4"S	7/16-20	1/8"M	5	28.5	11	15	100	
C-010	1/4"M×1/4"S	7/16-20	1/4"M	5	30.3	14	20	100	
C-011-1	1/4"M×5/16"S	1/2-20	1/4"M	6	31	14	21	100	
C-011	1/4"M×3/8"S	5/8-18	1/4"M	8	35	17	30	100	
C-011-A	1/4"M×3/8"S-B	9/16-18	1/4"M	7	31	14		100	小頭(空壓機用)
C-011-2	1/4"M×1/2"S	3/4-16	1/4"M	10	39	19	41	50	
C-012-1	3/8"M×1/4"S	7/16-20	3/8"M	5	31.3	17	27	100	
C-012-2	3/8"M×5/16"S	1/2-20	3/8"M	6	32	17	28	100	
C-012	3/8"M×3/8"S	5/8-18	3/8"M	8	35	17	32	100	
C-012-A	3/8"M×3/8"S-B	9/16-18	3/8"M	7	32	17		100	小頭(空壓機用)
C-013-1	3/8"M×1/2"S	3/4-16	3/8"M	10	39	19	43	50	
C-013-2	1/2"M×1/4"S	7/16-20	1/2"M	5	33	20.7	36	50	
C-013-3	1/2"M×5/16"S	1/2-20	1/2"M	6	33.5	20.7	38	50	
C-013-4	1/2"M×3/8"S	5/8-18	1/2"M	8	38	20.7	44	50	
C-013-4-A	1/2"M×3/8"S-B	9/16-18	1/2"M	7	34	20.7		50	小頭(空壓機用)
C-013	1/2"M×1/2"S	3/4-16	1/2"M	10	40	20.7	49	50	
C-013-5	1/2"M×5/8"S	7/8-14	1/2"M	12.7	37.5	23		20	
C-013-6	1/2"M×3/4"S	1 1/16-14	1/2"M	15	39.5	27		20	
C-013-7	3/4"M×3/8"S	9/16-18	3/4"M	8	37.5	27		20	
C-013-8	3/4"M×1/2"S	3/4-16	3/4"M	10	39.5	27		20	
C-013-9	3/4"M×5/8"S	7/8-14	3/4"M	12.7	40.5	27		20	
C-013-10	3/4"M×3/4"S	1 1/16-14	3/4"M	15.9	42.5	27		20	

※本頁庫存品皆為PT牙，如需NPT牙、特殊牙需訂製。訂購量以包裝為準，不零售。

※線圖尺寸僅供參考，詳細尺寸以現品為準。



喇叭口銅管接頭

TRUMPET BRASS CONNECTOR FOR BRASS TUBE

代號：H：叉心 / M：外牙 / F：內牙 / S：喇叭口 / U：PU管

彎接頭 ELBOW

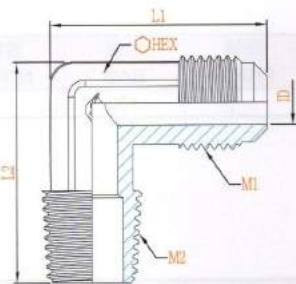

編號 ORDER NO.	規格 DIMENSION	M1	M2	ID	L1	L2	HEX.	牌價 PRICE	包裝 BAG	備註 NOTE
C-014	1/8"M×1/4"S	7/16-20	1/8"M	5	27.4	25.4	9.5	29	100	
C-014-1	1/8"M×5/16"S	1/2-20	1/8"M	6	29.5	27.5	10	36	50	
C-015	1/4"M×1/4"S	7/16-20	1/4"M	5	27.5	30	10	35	100	
C-016	1/4"M×5/16"S	1/2-20	1/4"M	6	29.7	30.2	10	37	100	
C-017-1	1/4"M×3/8"S	5/8-18	1/4"M	8	31.6	31	11	52	50	
C-017-1-A	1/4"M×3/8"S-B	9/16-18	1/4"M	8	32.5	32	12		50	小頭(空壓機用)
C-017-2	1/4"M×1/2"S	3/4-16	1/4"M	10.5	36.3	33.2	13	64	50	
C-017-3	3/8"M×1/4"S	7/16-20	3/8"M	5	28.5	30.1	11	44	50	
C-017-4	3/8"M×5/16"S	1/2-20	3/8"M	6	30.1	31	11	50	50	
C-017	3/8"M×3/8"S	5/8-18	3/8"M	8.5	33.6	32.1	13	57	50	
C-017-0	3/8"M×3/8"S-B	9/16-18	3/8"M	7.5	32	30.6	11		50	小頭(空壓機用)
C-018	3/8"M×1/2"S	3/4-16	3/8"M	10.5	36	32.5	13	76	30	
C-018-1	1/2"M×1/4"S	7/16-20	1/2"M	5	32.3	36.1	13	63	30	
C-018-2	1/2"M×5/16"S	1/2-20	1/2"M	6	34	36.1	13	62	30	
C-018-3	1/2"M×3/8"S	5/8-18	1/2"M	8.5	33.5	35.4	13	77	30	
C-018-3-B	1/2"M×3/8"S-B	9/16-18	1/2"M	8	34.3	36	13		30	小頭(空壓機用)
C-018-4	1/2"M×1/2"S	3/4-16	1/2"M	10.5	37.4	36.4	14	88	30	
C-018-5	1/2"M×5/8"S	7/8-14	1/2"M	12.7	46	44	21		30	
C-018-6	1/2"M×3/4"S	1 1/16-14	1/2"M	15.9	48	44	21		30	
C-018-7	3/4"M×3/8"S	9/16-18	3/4"M	8.5	41	46	21		30	
C-018-8	3/4"M×1/2"S	3/4-16	3/4"M	10.5	42	46	21		30	
C-018-9	3/4"M×5/8"S	7/8-14	3/4"M	12.7	46	46	21		30	
C-018-10	3/4"M×3/4"S	1 1/16-14	3/4"M	15.9	48	46	21		30	

公牙三通接頭 MALE RAN TEE

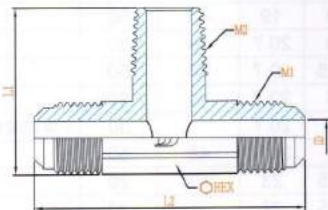

編號 ORDER NO.	規格 DIMENSION	M1	M2	ID	L1	L2	HEX.	牌價 PRICE	包裝 BAG	備註 NOTE
C-019	1/8"M×1/4"S	7/16-20	1/8"M	5	24.3	38.5	9.5	41	50	
C-020	1/4"M×1/4"S	7/16-20	1/4"M	5	29.2	43	11.5	57	50	
C-020-1	1/4"M×5/16"S	1/2-20	1/4"M	6	29.2	48	11.5	60	50	
C-020-2	1/4"M×3/8"S	5/8-18	1/4"M	8.5	29.7	51.8	12.5	79	50	
C-020-3	1/4"M×1/2"S	3/4-16	1/4"M	10.5	33.4	62.3	15.5	116	50	
C-021	3/8"M×1/4"S	7/16-20	3/8"M	5	33.9	49.7	12	76	30	
C-021-1	3/8"M×5/16"S	1/2-20	3/8"M	6	33.9	47.8	12	77	30	
C-021-2	3/8"M×3/8"S	5/8-18	3/8"M	8.5	30.2	51.8	12.5	80	30	
C-022	3/8"M×1/2"S	3/4-16	3/8"M	10.5	33.9	62.3	15.5	116	30	
C-022-1	1/2"M×1/4"S	7/16-20	1/2"M	5	36.9	48.3	13	113	30	
C-022-2	1/2"M×5/16"S	1/2-20	1/2"M	6	36.9	53.3	13	114	20	
C-022-3	1/2"M×3/8"S	5/8-18	1/2"M	8.5	36.9	57.3	13	119	20	
C-022-4	1/2"M×1/2"S	3/4-16	1/2"M	10.5	36.9	62.3	15.5	124	20	
C-022-5	3/4"M×3/8"S								15	訂製品
C-022-6	3/4"M×1/2"S								15	訂製品
C-022-7	3/4"M×5/8"S								15	訂製品
C-022-8	3/4"M×3/4"S								15	訂製品

編號 ORDER NO.	規格 DIMENSION	M1	M2	L	ID	HEX.	牌價 PRICE	包裝 BAG	備註 NOTE
C-020-2-B	1/4"M×3/8"S-B							50	小頭(訂製品)
C-021-2-B	3/8"M×3/8"S-B							30	小頭(訂製品)
C-022-3-B	1/2"M×3/8"S-B							20	小頭(訂製品)
C-022-5-B	3/4"M×3/8"S-B							15	小頭(訂製品)

※本頁庫存品皆為PT牙，如需NPT牙、特殊牙需訂製。訂購量以包裝為準，不零售。
※線圖尺寸僅供參考，詳細尺寸以現品為準。

喇叭口銅管接頭

TRUMPET BRASS CONNECTOR FOR BRASS TUBE



代號：H：叉心 / M：外牙 / F：內牙 / S：喇叭口 / U：PU管

由任直接頭

UNION CONNECTOR

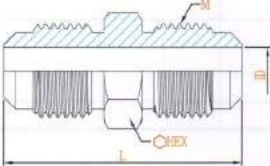

編號 ORDER NO.	規格 DIMENSION	M	ID	L	HEX.	牌價 PRICE	包裝 BAG	備註 NOTE
C-024	1/4"S	7/16-20	5	31.5	11	17	50	
C-025	5/16"S	1/2-20	6	33	14	23	50	
C-026	3/8"S	5/8-18	8	39.5	17	36	50	
C-027	1/2"S	3/4-16	10	46.5	19	53	30	
C-027-1	5/8"S	7/8-14	12.7	44	23		30	訂製品
C-027-2	3/4"S	1 1/16-14	15.9	49	27		20	訂製品

內牙喇叭

FEMALE FLARE
CONNECTOR

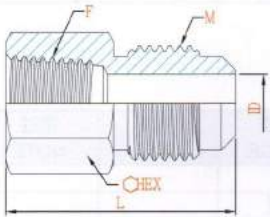

編號 ORDER NO.	規格 DIMENSION	F	M	ID	L	HEX.	牌價 PRICE	包裝 BAG	備註 NOTE
C-028-1	1/8"F×1/4"S	1/8"F	7/16-20	5	24	12		50	
C-028-2	1/8"F×5/16"S	1/8"F	1/2-20	6	25	13		50	
C-028-3	1/4"F×1/4"S	1/4"F	7/16-20	5	27	17		50	
C-028-4	1/4"F×5/16"S	1/4"F	1/2-20	6	28	17		50	
C-028-5	1/4"F×3/8"S-B	1/4"F	9/16-18	8	29	17		50	小頭
C-028-6	1/4"F×3/8"S	1/4"F	5/8-18	8.5	30	17		50	
C-028-7	3/8"F×3/8"S-B	3/8"F	9/16-18	8	29	20.5		30	小頭
C-028-8	3/8"F×3/8"S	3/8"F	5/8-18	8.5	30	20.5		30	
C-028-9	1/2"F×3/8"S	1/2"F	5/8-18	8.5	33	24		30	

由任彎接頭

UNION ELBOE

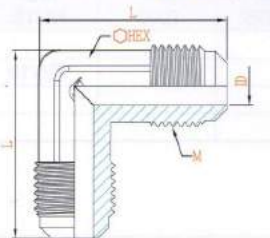

編號 ORDER NO.	規格 DIMENSION	M	ID	L	HEX.	牌價 PRICE	包裝 BAG	備註 NOTE
C-029	L1/4"S	7/16-20	5	27.2	9.5	28	50	
C-030	L5/16"S	1/2-20	6	29.7	10	39	50	
C-031	L3/8"S	5/8-18	8.5	33.6	13	58	50	
C-032	L1/2"S	3/4-16	10.5	37.4	14	87	50	
C-032-1	L5/8"S						50	訂製品
C-032-2	L3/4"S						30	訂製品

三通由任

UNION TEE

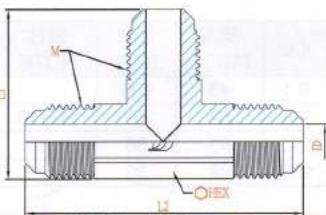

編號 ORDER NO.	規格 DIMENSION	M	ID	L1	L2	HEX.	牌價 PRICE	包裝 BAG	備註 NOTE
C-034	T1/4"S	7/16-20	5	24.5	38.5	9.5	42	50	
C-035	T5/16"S	1/2-20	6	29.2	48	11.5	61	50	
C-036	T3/8"S	5/8-18	8.5	31.7	51.8	12.5	82	50	
C-037	T1/2"S	3/4-16	10.5	37.9	62.3	15.5	122	30	
C-037-1	T5/8"S							30	訂製品
C-037-2	T3/4"S							20	訂製品

編號 ORDER NO.	規格 DIMENSION	M	L1	L2	ID	HEX.	牌價 PRICE	包裝 BAG	備註 NOTE
C-036-A	T3/8"S-B						82	50	小頭

※本頁庫存品皆為PT牙，如需NPT牙、特殊牙需訂製。訂購量以包裝為準，不需賣。

※線圖尺寸僅供參考，詳細尺寸以現品為準。



銅管用接頭(銅仁)

BRASS CONNECTOR FOR BRASS TUBE(TONGREN)

代號：H：叉心 / M：外牙 / F：內牙 / S：喇叭口 / U：PU管

銅管仁仔 BRASS FERRULE

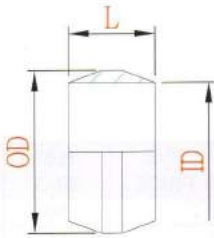

英制INCH

編號 ORDER NO.	規格 DIMENSION	ID	OD	L	牌價 PRICE	包裝 BAG	備註 NOTE
C-040	1/4"	6.5	8.5	5.2	3		
C-041	5/16"	8.1	10.5	6	4		
C-042	3/8"	9.7	12	6.3	5		
C-043	1/2"	12.9	14.5	8	6		
C-046-1	5/8"	16.1	19	8			
C-046-2	3/4"	19.3	22	8.3			

公制METRIC

編號 ORDER NO.	規格 DIMENSION	ID	OD	L	牌價 PRICE	包裝 BAG	備註 NOTE
C-038	4m/m	4.1	6	5.2	3		
C-039	6m/m	6.1	8.5	5.2	3		
C-044	8m/m	8.1	10.5	6	4		同5/16
C-045	10m/m	10.2	12	6.4	5		
C-046	12m/m	12.2	14.5	8.2	6		

銅管六角 HEXANGULAR

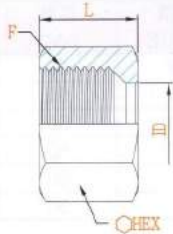
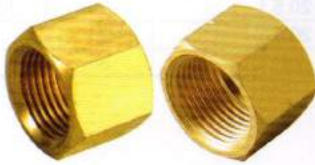

英制INCH

編號 ORDER NO.	規格 DIMENSION	F	ID	L	HEX.	牌價 PRICE	包裝 BAG	備註 NOTE
C-048	1/4"	M11x1.0	6.5	11	14	9		
C-049	5/16"	1/2-24	8.1	12.5	16	12		
C-049-1	3/8"	9/16-24	9.7	12.5	17	13		
C-049-2	1/2"	11/16-20	12.9	14	20.5	19		
C-049-7	5/8"	13/16-18	16.1	15	24			
C-049-8	3/4"	1"-18	19.3	16.5	30			

公制METRIC

編號 ORDER NO.	規格 DIMENSION	F	ID	L	HEX.	牌價 PRICE	包裝 BAG	備註 NOTE
C-047	6m/m	M11x1.0	6.1	11	14			
C-049-3	8m/m	1/2-24	8.1	12.5	16			同5/16
C-049-4	10m/m	9/16-24	10.2	12.5	17			
C-049-5	12m/m	11/16-20	12.2	14	20.5			

雙頭銅管 DOUBLE HEAD

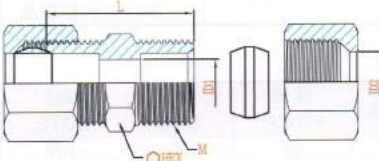

英制INCH

編號 ORDER NO.	規格 DIMENSION	M	ID1	L	HEX.	ID2	牌價 PRICE	包裝 BAG	備註 NOTE
C-050	1/4"R×1/4"R	M11x1.0	5.6	23	11	6.5	43	100	
C-051	5/16"R×5/16"R	1/2-24	6.5	23	13	8.1	57	50	
C-052	3/8"R×3/8"R	9/16-24	8	26	14.3	9.7	63	50	
C-053	1/2"R×1/2"R	11/16-20	10	31.7	17.5	12.9	88	30	
C-054-1	5/8"R×5/8"R								訂製品
C-054	3/4"R×3/4"R								訂製品

公制METRIC

編號 ORDER NO.	規格 DIMENSION	M	ID1	L	HEX.	ID2	牌價 PRICE	包裝 BAG	備註 NOTE
C-050-6MM	6R×6R	M11x1.0	5.6	23	11	6.1	43	100	
C-051-8MM	8R×8R	1/2-24	6.5	23	13	8.1	57	50	同5/16
C-052-10MM	10R×10R	9/16-24	8	26	14.3	10.2	63	50	
C-053-12MM	12R×12R	11/16-20	10	31.7	17.5	12.2	88	30	

※本頁庫存品皆為PT牙，如需NPT牙、特殊牙需訂製。訂購量以包裝為準，不需費。
※線圖尺寸僅供參考，詳細尺寸以現品為準。

銅管用接頭(銅仁)

BRASS CONNECTOR FOR BRASS TUBE(TONGREN)

代號：H：叉心 / M：外牙 / F：內牙 / S：喇叭口 / U：PU管

雙頭90°銅管 90° DOUBLE HEAD

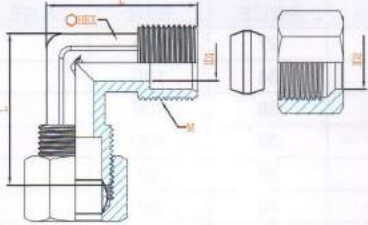

英制INCH

編號 ORDER NO.	規格 DIMENSION	M	ID1	L	HEX.	ID2	牌價 PRICE	包裝 BAG	備註 NOTE
C-055	1/4"R×1/4"R	M11x1.0	5.6	24.4	9.5	6.5	59	50	
C-056	5/16"R×5/16"R	1/2-24	7	27.2	10	8.1	77	50	
C-057	3/8"R×3/8"R	9/16-24	7	28.8	10	9.7	81	50	
C-058	1/2"R×1/2"R	11/16-20	10	33.4	13	12.9	112	20	
C-059-1	5/8"R×5/8"R								訂製品
C-059-2	3/4"R×3/4"R								訂製品

公制METRIC

編號 ORDER NO.	規格 DIMENSION	M	ID1	L	HEX.	ID2	牌價 PRICE	包裝 BAG	備註 NOTE
C-055-6MM	6R×6R	M11x1.0	5.6	24.4	9.5	6.1	59	50	
C-056-8MM	8R×8R	1/2-24	7	27.2	10	8.1	77	50	同5/16
C-057-10MM	10R×10R	9/16-24	7	28.8	10	10.2	81	50	
C-058-12MM	12R×12R	11/16-20	10	33.4	13	12.2	112	20	

T型三頭銅管 THREE HEAD

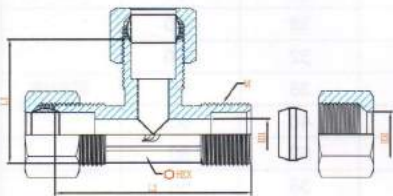

英制INCH

編號 ORDER NO.	規格 DIMENSION	M	ID1	L1	L2	HEX.	ID2	牌價 PRICE	包裝 BAG	備註 NOTE
C-060	1/4"R	M11x1.0	5.6	24.4	38	9.5	6.5	85	50	
C-061	5/16"R	1/2-24	7	26.7	43	11.5	8.1	117	30	
C-062	3/8"R	9/16-24	7.5	28.2	44.8	11.5	9.7	124	30	
C-063	1/2"R	11/16-20	10	31.5	50	12.5	12.9	165	20	
C-063-1	5/8"R									訂製品
C-063-2	3/4"R									訂製品

公制METRIC

編號 ORDER NO.	規格 DIMENSION	M	ID1	L1	L2	HEX.	ID2	牌價 PRICE	包裝 BAG	備註 NOTE
C-060-6MM	6R	M11x1.0	5.6	24.4	38	9.5	6.1	85	50	
C-061-8MM	8R	1/2-24	7	26.7	43	11.5	8.1	117	30	同5/16
C-062-10MM	10R	9/16-24	7.5	28.2	44.8	11.5	10.2	124	30	
C-063-12MM	12R	11/16-20	10	31.5	50	12.5	12.2	165	20	

※本頁庫存品皆為PT牙，如需NPT牙、特殊牙需訂製。訂購量以包裝為準，不零售。

※線圖尺寸僅供參考，詳細尺寸以現品為準。



銅管用接頭(銅仁)

BRASS CONNECTOR FOR BRASS TUBE(TONGREN)

代號：H：叉心 / M：外牙 / F：內牙 / S：喇叭口 / U：PU管

直外牙銅管

MALE AND CONNECTOR

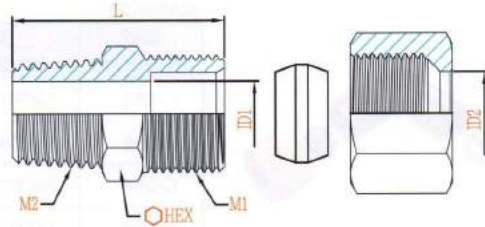

英制INCH

編號 ORDER NO.	規格 DIMENSION	M1	M2	ID1	L	HEX.	ID2	牌價 PRICE	包裝 BAG	備註 NOTE
C-064	1/8"×1/4"R	M11x1.0	1/8"×M	5.7	23.5	11	6.5	27	100	
C-064-1	1/8"×5/16"R	1/2-24	1/8"×M	6.5	24	13	8.1	34	100	
C-064-2	1/8"×3/8"R	9/16-24	1/8"×M	7.5	24.5	14.3	9.7	38	100	
C-065	1/4"×1/4"R	M11x1.0	1/4"×M	5.5	24	14	6.5	32	100	
C-066	1/4"×5/16"R	1/2-24	1/4"×M	6.5	24.5	14	8.1	38	50	
C-066-1	1/4"×3/8"R	9/16-24	1/4"×M	8	26	14.3	9.7	40	50	
C-067-1	1/4"×1/2"R	11/16-20	1/4"×M	8	27	17	12.9	52	50	
C-067-2	3/8"×1/4"R	M11x1.0	3/8"×M	5.5	25.5	17	6.5	38	50	
C-067-3	3/8"×5/16"R	1/2-24	3/8"×M	6.5	25.5	17	8.1	43	50	
C-067	3/8"×3/8"R	9/16-24	3/8"×M	8	27.5	17	9.7	46	50	
C-068	3/8"×1/2"R	11/16-20	3/8"×M	10	28	17	12.9	54	50	
C-068-1	1/2"×1/4"R	M11x1.0	1/2"×M	5.5	27	20.7	6.5	49	50	
C-068-2	1/2"×5/16"R	1/2-24	1/2"×M	6.5	27	20.7	8.1	53	50	
C-068-3	1/2"×3/8"R	9/16-24	1/2"×M	8	27	20.7	9.7	56	50	
C-068-4	1/2"×1/2"R	11/16-20	1/2"×M	11.5	35	20.7	12.9	71	50	
C-069-1	1/2"×5/8"R	13/16-18	1/2"×M	14.5	30	20.7	16.1		30	
C-069-2	1/2"×3/4"R	1"-18	1/2"×M	15	32	26	19.3		20	訂製品
C-069-3	3/4"×5/8"R	13/16-18	3/4"×M	14.5	33	27	16.1		20	訂製品
C-069	3/4"×3/4"R	1"-18	3/4"×M	17	34	27	19.3		20	訂製品

公制METRIC

編號 ORDER NO.	規格 DIMENSION	M1	M2	ID1	L	HEX.	ID2	牌價 PRICE	包裝 BAG	備註 NOTE
C-064-6MM	1/8"×6R	M11x1.0	1/8"×M	5.7	23.5	11	6.1	27	100	
C-064-1-8MM	1/8"×8"R	1/2-24	1/8"×M	6.5	24	13	8.1	34	100	同5/16
C-064-2-10MM	1/8"×10R	9/16-24	1/8"×M	7.5	24.5	14.3	10.2	38	100	
C-065-6MM	1/4"×6R	M11x1.0	1/4"×M	5.5	24	14	6.1	32	100	
C-066-8MM	1/4"×8R	1/2-24	1/4"×M	6.5	24.5	14	8.1	38	50	同5/16
C-066-1-10MM	1/4"×10R	9/16-24	1/4"×M	8	26	14.3	10.2	40	50	
C-067-1-12MM	1/4"×12R	11/16-20	1/4"×M	8	27	17	12.2	52	50	
C-067-2-6MM	3/8"×6R	M11x1.0	3/8"×M	5.5	25.5	17	6.1	38	50	
C-067-3-8MM	3/8"×8R	1/2-24	3/8"×M	6.5	25.5	17	8.1	43	50	同5/16
C-067-10MM	3/8"×10R	9/16-24	3/8"×M	8	27.5	17	10.2	46	50	
C-068-12MM	3/8"×12R	11/16-20	3/8"×M	10	28	17	12.2	54	50	
C-068-1-6MM	1/2"×6R	M11x1.0	1/2"×M	5.5	27	20.7	6.1	49	50	
C-068-2-8MM	1/2"×8R	1/2-24	1/2"×M	6.5	27	20.7	8.1	53	50	同5/16
C-068-3-10MM	1/2"×10R	9/16-24	1/2"×M	8	27	20.7	10.2	56	50	
C-068-4-12MM	1/2"×12R	11/16-20	1/2"×M	11.5	35	20.7	12.2	71	50	

※本頁庫存品皆為PT牙，如需NPT牙、特殊牙需訂製。訂購量以包裝為準，不零售。
※線圖尺寸僅供參考，詳細尺寸以現品為準。

銅管用接頭(銅仁) BRASS CONNECTOR FOR BRASS TUBE(TONGREN)

代號：H：叉心 / M：外牙 / F：內牙 / S：喇叭口 / U：PU管

內牙直銅管 FEMALE AND CONNECTOR



英制INCH

編號 ORDER NO.	規格 DIMENSION	F	M	ID1	L	HEX.	ID2	牌價 PRICE	包裝 BAG	備註 NOTE
C-070-1	1/8" F × 1/4" R	1/8" F	M11x1.0	5.5	21	12	6.5	28	100	
C-070-3	1/8" F × 5/16" R	1/8" F	1/2-24	6.5	22	14	8.1		100	
C-070-3A	1/8" F × 3/8" R	1/8" F	9/16-24	8.5	21	14.3	9.7			
C-070-3B	1/8" F × 1/2" R	1/8" F	11/16-20	11.5	22	18	12.9			訂製品
C-070	1/4" F × 1/4" R	1/4" F	M11x1.0	5.5	22.3	16	6.5	34	100	
C-071-1	1/4" F × 5/16" R	1/4" F	1/2-24	6.5	23	16	8.1	40	50	
C-071	1/4" F × 3/8" R	1/4" F	9/16-24	8	24.5	16	9.7	44	100	
C-071-2	1/4" F × 1/2" R	1/4" F	11/16-20	11.4	25	18	12.9			
C-072-1	3/8" F × 1/4" R	3/8" F	M11x1.0	5.5	26	19	6.5	42	50	
C-072-2	3/8" F × 5/16" R	3/8" F	1/2-24	6.5	24	19	8.1	46	50	
C-072	3/8" F × 3/8" R	3/8" F	9/16-24	9	27	19	9.7	50	50	
C-072-3	3/8" F × 1/2" R	3/8" F	11/16-20	11.5	25	19	12.9			
C-073-1A	1/2" F × 1/4" R	1/2" F	M11x1.0	5.5	25.5	24	6.5			
C-073-2	1/2" F × 5/16" R	1/2" F	1/2-24	6.5	26	24	8.1			
C-073-1	1/2" F × 3/8" R	1/2" F	9/16-24	9	27.5	24	9.7		30	
C-073	1/2" F × 1/2" R	1/2" F	11/16-20	11.5	29.2	24	12.9	72	30	

公制METRIC

編號 ORDER NO.	規格 DIMENSION	F	M	ID1	L	HEX.	ID2	牌價 PRICE	包裝 BOX	備註 NOTE
C-070-1-6MM	1/8" F × 6R	1/8" F	M11x1.0	5.5	21	12	6.1	28	100	
C-070-3-8MM	1/8" F × 8R	1/8" F	1/2-24	6.5	22	14	8.1			同5/16
C-070-3A-10MM	1/8" F × 10R	1/8" F	9/16-24	8.5	21	14.3	10.2			
C-070-3B-12MM	1/8" F × 12R	1/8" F	11/16-20	11.5	22	18	12.2			訂製品
C-070-6MM	1/4" F × 6R	1/4" F	M11x1.0	5.5	22.3	16	6.1	34		
C-071-1-8MM	1/4" F × 8R	1/4" F	1/2-24	6.5	23	16	8.1	40	50	同5/16
C-071-10MM	1/4" F × 10R	1/4" F	9/16-24	8	24.5	16	10.2	44	100	
C-071-2-12MM	1/4" F × 12R	1/4" F	11/16-20	11.4	25	18	12.2			
C-072-1-6MM	3/8" F × 6R	3/8" F	M11x1.0	5.5	26	19	6.1	42	50	
C-072-2-8MM	3/8" F × 8R	3/8" F	1/2-24	6.5	24	19	8.1	46	50	同5/16
C-072-10MM	3/8" F × 10R	3/8" F	9/16-24	9	27	19	10.2	50	50	
C-072-3-12MM	3/8" F × 12R	3/8" F	11/16-20	11.5	25	19	12.2			
C-073-1A-6MM	1/2" F × 6R	1/2" F	M11x1.0	5.5	25.5	24	6.1			
C-073-2-8MM	1/2" F × 8R	1/2" F	1/2-24	6.5	26	24	8.1			同5/16
C-073-1-10MM	1/2" F × 10R	1/2" F	9/16-24	9	27.5	24	10.2			
C-073-12MM	1/2" F × 12R	1/2" F	11/16-20	11.5	29.2	24	12.2	72	30	

90°外牙銅管 90° MALE AND CONNECTOR

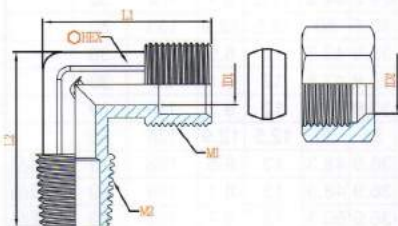

英制INCH

編號 ORDER NO.	規格 DIMENSION	M1	M2	ID1	L1	L2	HEX.	ID2	牌價 PRICE	包裝 BOX	備註 NOTE
C-075-1	1/8" M × 1/4" R	M11x1.0	1/8" M	5.6	25.2	25.4	9.5	6.5	43	100	
C-075-2	1/8" M × 5/16" R	1/2-24	1/8" M	7	27.5	27.5	10	8.1	53	100	
C-075-3	1/8" M × 3/8" R	9/16-24	1/8" M	7	28.5	27.5	10	9.7	56	100	
C-075	1/4" M × 1/4" R	M11x1.0	1/4" M	5.6	27.1	30	10	6.5	50	100	
C-076	1/4" M × 5/16" R	1/2-24	1/4" M	7	29	30.2	10	8.1	58	50	
C-077-1	1/4" M × 3/8" R	9/16-24	1/4" M	7	29	30.2	10	9.7	60	50	
C-077-2	1/4" M × 1/2" R	11/16-20	1/4" M	7	31	31.5	11	12.9	81	50	
C-077-3	3/8" M × 1/4" R	M11x1.0	3/8" M	5.6	28.5	30.1	11	6.5	58	50	
C-077-4	3/8" M × 5/16" R	1/2-24	3/8" M	7	28.5	30.5	11	8.1	67	50	
C-077	3/8" M × 3/8" R	9/16-24	3/8" M	7.5	29.5	30.5	11	9.7	69	50	
C-078-1	3/8" M × 1/2" R	11/16-20	3/8" M	10	32.5	32.5	13	12.9	84	30	
C-078-2	1/2" M × 1/4" R	M11x1.0	1/2" M	5.6	30.5	36	13	6.5	78	50	
C-078-3	1/2" M × 5/16" R	1/2-24	1/2" M	7	31	36	13	8.1	81	50	
C-078-4	1/2" M × 3/8" R	9/16-24	1/2" M	7.5	32.2	36	13	9.7	83	30	
C-078-5	1/2" M × 1/2" R	11/16-20	1/2" M	10	32.4	35.2	13	12.9	102	30	
C-078-6	1/2" M × 5/8" R										訂製品
C-078-7	1/2" M × 3/4" R										訂製品
C-078-8	3/4" M × 5/8" R										訂製品
C-078-9	3/4" M × 3/4" R										訂製品

※本頁庫存品皆為PT牙，如需NPT牙、特殊牙需訂製。訂購量以包裝為準，不零售。

※線圖尺寸僅供參考，詳細尺寸以現品為準。

銅管用接頭(銅仁)

BRASS CONNECTOR FOR BRASS TUBE(TONGREN)

代號：H：叉心 / M：外牙 / F：內牙 / S：喇叭口 / U：PU管

90°外牙銅管

90° MALE AND CONNECTOR

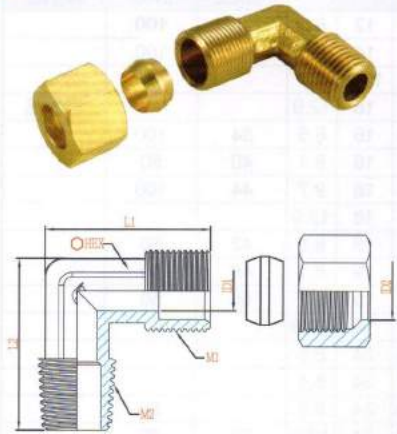

公制METRIC

編號 ORDER NO.	規格 DIMENSION	M1	M2	ID1	L1	L2	HEX.	ID2	牌價 PRICE	包裝 BOX	備註 NOTE
C-075-1-6MM	1/8"×6R	M11×1.0	1/8"×M	5.6	25.2	25.4	9.5	6.1	43	100	
C-075-2-8MM	1/8"×8R	1/2-24	1/8"×M	7	27.5	27.5	10	8.1	53	100	同5/16
C-075-3-10MM	1/8"×10R	9/16-24	1/8"×M	7	28.5	27.5	10	10.2	56	100	
C-075-6MM	1/4"×6R	M11×1.0	1/4"×M	5.6	27.1	30	10	6.1	50	100	
C-076-8MM	1/4"×8R	1/2-24	1/4"×M	7	29	30.2	10	8.1	58	50	同5/16
C-077-1-10MM	1/4"×10R	9/16-24	1/4"×M	7	29	30.2	10	10.2	60	50	
C-077-2-12MM	1/4"×12R	11/16-20	1/4"×M	7	31	31.5	11	12.2	81	50	
C-077-3-6MM	3/8"×6R	M11×1.0	3/8"×M	5.6	28.5	30.1	11	6.1	58	50	
C-077-4-8MM	3/8"×8R	1/2-24	3/8"×M	7	28.5	30.5	11	8.1	67	50	同5/16
C-077-10MM	3/8"×10R	9/16-24	3/8"×M	7.5	29.5	30.5	11	10.2	69	50	
C-078-1-12MM	3/8"×12R	11/16-20	3/8"×M	10	32.5	32.5	13	12.2	84	30	
C-078-2-6MM	1/2"×6R	M11×1.0	1/2"×M	5.6	30.5	36	13	6.1	78	50	
C-078-3-8MM	1/2"×8R	1/2-24	1/2"×M	7	31	36	13	8.1	81	50	同5/16
C-078-4-10MM	1/2"×10R	9/16-24	1/2"×M	7.5	32.2	36	13	10.2	83	30	
C-078-5-12MM	1/2"×12R	11/16-20	1/2"×M	10	32.4	35.2	13	12.2	102	30	

90°內牙銅管

90° FEMALE AND CONNECTOR

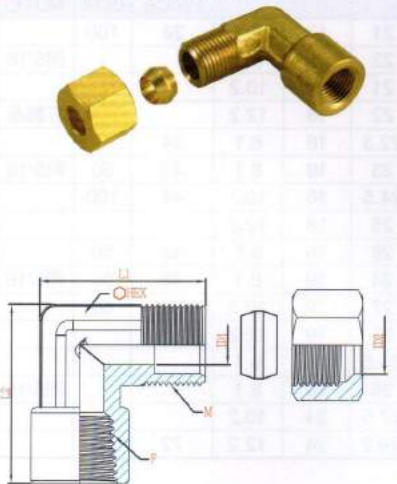

英制INCH

編號 ORDER NO.	規格 DIMENSION	F	M	ID1	L1	L2	HEX.	ID2	牌價 PRICE	包裝 BOX	備註 NOTE
C-079	1/8"×1/4"R	1/8"×F	M11×1.0	5.6	27.1	29.5	10	6.5	46	50	
C-079-1	1/8"×5/16"R	1/8"×F	1/2-24	7	27.5	29.5	10	8.1			
C-080-1	1/4"×1/4"R	1/4"×F	M11×1.0	5.6	28.5	32.1	11	6.5	60	50	
C-080	1/4"×5/16"R	1/4"×F	1/2-24	7	28.5	32.1	11	8.1	69	50	
C-081-1	1/4"×3/8"R	1/4"×F	9/16-24	7.5	29.5	32.1	11	9.7	71	50	
C-081-2	3/8"×1/4"R	3/8"×F	M11×1.0	5.6	30.5	36	13	6.5	108	30	
C-081-3	3/8"×5/16"R	3/8"×F	1/2-24	7	31	36	13	8.1	108	30	
C-081	3/8"×3/8"R	3/8"×F	9/16-24	7.5	33.3	36	13	9.7	102	30	

公制METRIC

編號 ORDER NO.	規格 DIMENSION	F	M	ID1	L1	L2	HEX.	ID2	牌價 PRICE	包裝 BOX	備註 NOTE
C-079-6MM	1/8"×6R	1/8"×F	M11×1.0	5.6	27.1	29.5	10	6.1	46	50	
C-079-1-8MM	1/8"×8R	1/8"×F	1/2-24	7	27.5	29.5	10	8.1		50	同5/16
C-080-1-6MM	1/4"×6R	1/4"×F	M11×1.0	5.6	28.5	32.1	11	6.1	60	50	
C-080-8MM	1/4"×8R	1/4"×F	1/2-24	7	28.5	32.1	11	8.1	69	50	同5/16
C-081-1-10MM	1/4"×10R	1/4"×F	9/16-24	7.5	29.5	32.1	11	10.2	71	50	
C-081-2-6MM	3/8"×6R	3/8"×F	M11×1.0	5.6	30.5	36	13	6.1	108	30	
C-081-3-8MM	3/8"×8R	3/8"×F	1/2-24	7	31	36	13	8.1	108	30	同5/16
C-081-10MM	3/8"×10R	3/8"×F	9/16-24	7.5	33.3	36	13	10.2	102	30	

T型外牙雙頭銅管

MALE T TYPE DOUBLE CONNECTOR

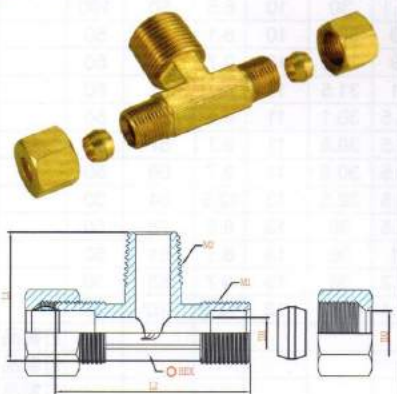

英制INCH

編號 ORDER NO.	規格 DIMENSION	M1	M2	ID1	L1	L2	HEX.	ID2	牌價 PRICE	包裝 BOX	備註 NOTE
C-082	1/8"×1/4"R×1/4"R	M11×1.0	1/8"×M	5.6	24.3	38	9.5	6.5	71	50	
C-082-1	1/8"×5/16"R×5/16"R	1/2-24	1/8"×M	7	27.7	43	11.5	8.1	98	50	
C-083-1	1/4"×1/4"R×1/4"R	M11×1.0	1/4"×M	5.6	29.2	43	11.5	6.5	84	50	
C-083	1/4"×5/16"R×5/16"R	1/2-24	1/4"×M	7	29.2	43	11.5	8.1	97	30	
C-084-1	1/4"×3/8"R×3/8"R	9/16-24	1/4"×M	7.5	29.2	44.8	11.5	9.7	102	50	
C-084-2	1/4"×1/2"R×1/2"R	11/16-20	1/4"×M	10	30.5	50	12.5	12.9	133	30	
C-084-3	3/8"×1/4"R×1/4"R	M11×1.0	3/8"×M	5.6	33.9	42.8	12	6.5	106	30	
C-084-4	3/8"×5/16"R×5/16"R	1/2-24	3/8"×M	7	33.9	42.8	12	8.1	90	30	
C-084	3/8"×3/8"R×3/8"R	9/16-24	3/8"×M	7.5	33.9	44.8	12	9.7	119	30	
C-085-1	3/8"×1/2"R×1/2"R	11/16-20	3/8"×M	10	31	50	12.5	12.9	135	20	
C-085-2	1/2"×1/4"R×1/4"R	M11×1.0	1/2"×M	5.6	36.9	48.3	13	6.5	138	20	訂製品
C-085-3	1/2"×5/16"R×5/16"R	1/2-24	1/2"×M	7	36.9	48.3	13	8.1	149	20	訂製品
C-085-4	1/2"×3/8"R×3/8"R	9/16-24	1/2"×M	7.5	36.9	50.3	13	9.7	153	20	訂製品
C-085-5	1/2"×1/2"R×1/2"R	11/16-20	1/2"×M	10	36.9	54.3	13	12.9	169	20	訂製品

※本頁庫存品皆為PT牙，如需NPT牙、特殊牙需訂製。訂購量以包裝為準，不零賣。
※線圖尺寸僅供參考，詳細尺寸以現品為準。

銅管用接頭(銅仁)

BRASS CONNECTOR FOR BRASS TUBE(TONGREN) 銅管接頭(銅仁)

代號：H：叉心 / M：外牙 / F：內牙 / S：喇叭口 / U：PU管



T型外牙雙頭銅管 MALE T TYPE DOUBLE CONNECTOR

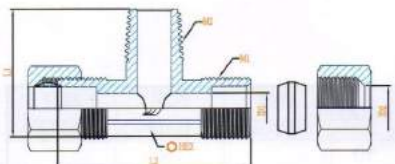

公制METRIC

編號 ORDER NO.	規格 DIMENSION	M1	M2	ID1	L1	L2	HEX.	ID2	牌價 PRICE	包裝 BOX	備註 NOTE
C-082-6MM	1/8"×6R×6R	M11x1.0	1/8"×M	5.6	24.3	38	9.5	6.1	71	50	
C-082-1-8MM	1/8"×8R×8R	1/2-24	1/8"×M	7	27.7	43	11.5	8.1	98	50	同5/16
C-083-1-6MM	1/4"×6R×6R	M11x1.0	1/4"×M	5.6	29.2	43	11.5	6.1	84	50	
C-083-8MM	1/4"×8R×8R	1/2-24	1/4"×M	7	29.2	43	11.5	8.1	97	50	同5/16
C-084-1-10MM	1/4"×10R×10R	9/16-24	1/4"×M	7.5	29.2	44.8	11.5	10.2	102	50	
C-084-2-12MM	1/4"×12R×12R	11/16-20	1/4"×M	10	30.5	50	12.5	12.2	133	30	
C-084-3-6MM	3/8"×6R×6R	M11x1.0	3/8"×M	5.6	33.9	42.8	12	6.1	106	30	
C-084-4-8MM	3/8"×8R×8R	1/2-24	3/8"×M	7	33.9	42.8	12	8.1	90	30	同5/16
C-084-10MM	3/8"×10R×10R	9/16-24	3/8"×M	7.5	33.9	44.8	12	10.2	119	30	
C-085-1-12MM	3/8"×12R×12R	11/16-20	3/8"×M	10	31	50	12.5	12.2	135	20	
C-085-2-6MM	1/2"×6R×6R	M11x1.0	1/2"×M	5.6	36.9	48.3	13	6.1	138	20	訂製品
C-085-3-8MM	1/2"×8R×8R	1/2-24	1/2"×M	7	36.9	48.3	13	8.1	149	20	訂製品
C-085-4-10MM	1/2"×10R×10R	9/16-24	1/2"×M	7.5	36.9	50.3	13	10.2	153	20	訂製品
C-085-5-12MM	1/2"×12R×12R	11/16-20	1/2"×M	10	36.9	54.3	13	12.2	169	20	訂製品

F型外牙銅管 MALE F TYPE DOUBLE CONNECTOR

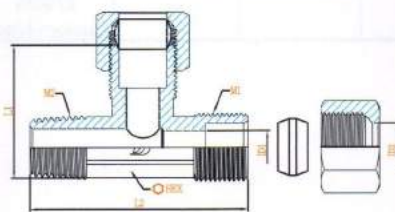

英制INCH

編號 ORDER NO.	規格 DIMENSION	M1	M2	ID1	L1	L2	HEX.	ID2	牌價 PRICE	包裝 BAG	備註 NOTE
C-086	1/8"×1/4"R×1/4"R	M11x1.0	1/8"×M	5.5	24.4	38	9.5	6.5	69	50	
C-087-1	1/8"×5/16"R×5/16"R	1/2-24	1/8"×M	7	26.7	44	11.5	8.1	97	50	
C-087	1/4"×1/4"R×1/4"R	M11x1.0	1/4"×M	5.6	26.7	45.5	11.5	6.5	86	50	
C-088	1/4"×5/16"R×5/16"R	1/2-24	1/4"×M	7	26.7	45.5	11.5	8.1	96	50	
C-089-1	1/4"×3/8"R×3/8"R	9/16-24	1/4"×M	7.5	27.7	46.3	11.5	9.7	90	30	
C-089-2	1/4"×1/2"R×1/2"R	11/16-20	1/4"×M	10	31.5	51	12.5	12.9	180	30	
C-089-3	3/8"×1/4"R×1/4"R	M11x1.0	3/8"×M	5.6	26.7	45.8	12.5	6.5	90	30	
C-089-4	3/8"×5/16"R×5/16"R	1/2-24	3/8"×M	7	26.7	45.8	12.5	8.1	90	30	
C-089	3/8"×3/8"R×3/8"R	9/16-24	3/8"×M	7.5	29.2	47.8	12.5	9.7	119	30	
C-090-1	3/8"×1/2"R×1/2"R	11/16-20	3/8"×M	10	31.5	51	12.5	12.9	134	20	
C-090-2	1/2"×1/4"R×1/4"R	M11x1.0	1/2"×M	5.6	30.9	54.3	15.5	6.5	180	20	訂製品
C-090-3	1/2"×5/16"R×5/16"R	1/2-24	1/2"×M	7	30.9	54.3	15.5	8.1	180	20	訂製品
C-090-4	1/2"×3/8"R×3/8"R	9/16-24	1/2"×M	7.5	31.9	55.3	15.5	9.7	153	20	訂製品
C-090	1/2"×1/2"R×1/2"R	11/16-20	1/2"×M	10	33.9	57.3	15.5	12.9	171	20	訂製品

公制METRIC

編號 ORDER NO.	規格 DIMENSION	M1	M2	ID1	L1	L2	HEX.	ID2	牌價 PRICE	包裝 BAG	備註 NOTE
C-086-6MM	1/8"×6R×6R	M11x1.0	1/8"×M	5.5	24.4	38	9.5	6.1	69	50	
C-087-1-8MM	1/8"×8R×8R	1/2-24	1/8"×M	7	26.7	44	11.5	8.1	97	50	同5/16
C-087-6MM	1/4"×6R×6R	M11x1.0	1/4"×M	5.6	26.7	45.5	11.5	6.1	86	50	
C-088-8MM	1/4"×8R×8R	1/2-24	1/4"×M	7	26.7	45.5	11.5	8.1	96	50	同5/16
C-089-1-10MM	1/4"×10R×10R	9/16-24	1/4"×M	7.5	27.7	46.3	11.5	10.2	90	30	
C-089-2-12MM	1/4"×12R×12R	11/16-20	1/4"×M	10	31.5	51	12.5	12.2	180	30	
C-089-3-6MM	3/8"×6R×6R	M11x1.0	3/8"×M	5.6	26.7	45.8	12.5	6.1	90	30	
C-089-4-8MM	3/8"×8R×8R	1/2-24	3/8"×M	7	26.7	45.8	12.5	8.1	90	30	同5/16
C-089-10MM	3/8"×10R×10R	9/16-24	3/8"×M	7.5	29.2	47.8	12.5	10.2	119	30	
C-090-1-12MM	3/8"×12R×12R	11/16-20	3/8"×M	10	31.5	51	12.5	12.2	134	20	
C-090-2-6MM	1/2"×6R×6R	M11x1.0	1/2"×M	5.6	30.9	54.3	15.5	6.1	180	20	訂製品
C-090-3-8MM	1/2"×8R×8R	1/2-24	1/2"×M	7	30.9	54.3	15.5	8.1	180	20	訂製品
C-090-4-10MM	1/2"×10R×10R	9/16-24	1/2"×M	7.5	31.9	55.3	15.5	10.2	153	20	訂製品
C-090-12MM	1/2"×12R×12R	11/16-20	1/2"×M	10	33.9	57.3	15.5	12.2	171	20	訂製品

※本頁庫存品皆為PT牙，如需NPT牙、特殊牙需訂製。訂購量以包裝為準，不零售。

※線圖尺寸僅供參考，詳細尺寸以現品為準。



銅管用潤滑油接頭 BRASS CONNECTOR FOR BRASS TUBE

代號：H：叉心 / M：外牙 / F：內牙 / S：喇叭口 / U：PU管

潤滑管路接頭(直) LUBRICITY HOSE CONNECTOR (STRAIGHT)

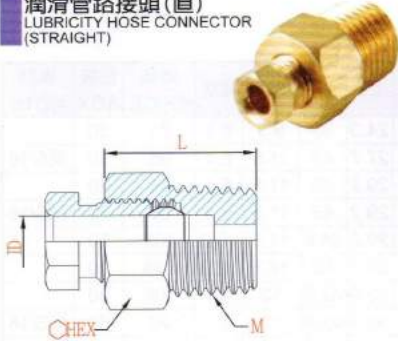

編號 ORDER NO.	規格 DIMENSION	M	ID	L	HEX.	牌價 PRICE	包裝 BAG	備註 NOTE
C-081-4	4mm × 1/8PT(直)	1/8PT	4.1	18	10		100	
C-081-5	4mm × 1/4PT(直)	1/4PT	4.1	18	14		100	
C-081-6	6mm × 1/8PT(直)	1/8PT	6.1	18	12		100	
C-081-7	6mm × 1/4PT(直)	1/4PT	6.1	18	14		100	
C-081-7-A	8mm × 1/8PT(直)	1/8PT	8.1	26	17		50	
C-081-7-B	8mm × 1/4PT(直)	1/4PT	8.1	26	17		50	

潤滑管路接頭(彎) LUBRICITY HOSE CONNECTOR (STOOP)

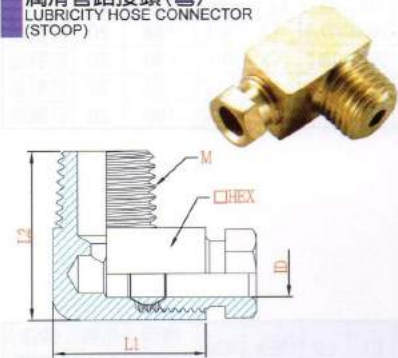

編號 ORDER NO.	規格 DIMENSION	M	ID	L1	L2	HEX.	牌價 PRICE	包裝 BAG	備註 NOTE
C-081-8	4mm × 1/8PT	1/8PT	4.1	18	18	10		100	
C-081-9	4mm × 1/4PT	1/4PT	4.1	20	22	14		50	
C-081-10	6mm × 1/8PT	1/8PT	6.1	20	20	12		100	
C-081-11	6mm × 1/4PT	1/4PT	6.1	20	22	14		50	
C-081-12	8mm × 1/8PT	1/8PT	8.1	27.8	28	17.5		50	
C-081-13	8mm × 1/4PT	1/4PT	8.1	27.8	33	17.5		50	

潤滑管路六角



編號 ORDER NO.	規格 DIMENSION	牌價 PRICE	包裝 BAG	備註 NOTE
C-081-B	4mm			
C-081-C	6mm			
C-081-G	8mm			

潤滑管路銅仁



編號 ORDER NO.	規格 DIMENSION	牌價 PRICE	包裝 BAG	備註 NOTE
C-081-A	4mm			
C-081-D	6mm			
C-081-F	8mm			

反向直接頭



編號 ORDER NO.	規格 DIMENSION	牌價 PRICE	包裝 BAG	備註 NOTE
				訂製品 Custom-Made

單向直接頭



編號 ORDER NO.	規格 DIMENSION	牌價 PRICE	包裝 BAG	備註 NOTE
				訂製品 Custom-Made

反向直角接頭



編號 ORDER NO.	規格 DIMENSION	牌價 PRICE	包裝 BAG	備註 NOTE
				訂製品 Custom-Made

單向直角接頭



編號 ORDER NO.	規格 DIMENSION	牌價 PRICE	包裝 BAG	備註 NOTE
				訂製品 Custom-Made

※以訂製為主，需一定數量。
※線圖尺寸僅供參考，詳細尺寸以現品為準。

外銷規格接頭—彎頭(美規NPT、NPTF牙)

EXPORT TRADE BRASS CONNECTOR - ELBOW (AMERICAN)



代號：H：叉心 / M：外牙 / F：內牙 / S：喇叭口 / U：PU管

切料90°雙內牙 DOUBLE FEMALE 90°

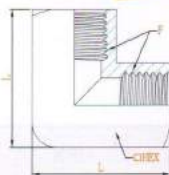

編號 ORDER NO.	規格 DIMENSION	F	L	HEX	備註 NOTE
022	1/8F×1/8F	1/8"F	20.5	14.26	
024	1/4F×1/4F	1/4"F	28.6	17.46	
026	3/8F×3/8F	3/8"F	31.8	20.64	
028	1/2F×1/2F	1/2"F	40.7	25.4	
0212	3/4F×3/4F	3/4"F	45.2	31.7	

切料T型外牙X內牙(2) MALE T TYPE AND DOUBLE FEMALE

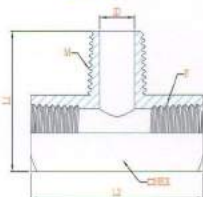

編號 ORDER NO.	規格 DIMENSION	M	F	L1	L2	ID	HEX	備註 NOTE
242	1/8M×1/8F	1/8"M	1/8"F	23.3	28	5.5	14.26	
244	1/4M×1/4F	1/4"M	1/4"F	31.9	39.6	8	17.46	
246	3/8M×3/8F	3/8"M	3/8"F	35.1	42.6	11	20.64	
248	1/2M×1/2F	1/2"M	1/2"F	44.5	55.6	14.3	25.4	
2412	3/4M×3/4F	3/4"M	3/4"F	49.7	55.8	19.1	31.7	

90°外牙插管 MALE 90° AND INLET TYPE



編號 ORDER NO.	規格 DIMENSION	A	B	備註 NOTE
012	1/8M X 1/4H	1/8M	1/4H	
013	1/8M X 3/8H	1/8M	3/8H	
022	1/4M X 1/4H	1/4M	1/4H	
023	1/4M X 3/8H	1/4M	3/8H	
024	1/4M X 1/2H	1/4M	1/2H	
032	3/8M X 1/4H	3/8M	1/4H	
033	3/8M X 3/8H	3/8M	3/8H	
034	3/8M X 1/2H	3/8M	1/2H	
043	1/2M X 3/8H	1/2M	3/8H	
044	1/2M X 1/2H	1/2M	1/2H	
044-1	3/4M X 3/4H	3/4M	3/4H	

切料90°內外牙 MALE / FEMALE 90°

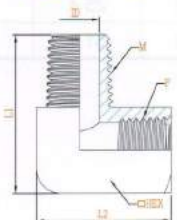

編號 ORDER NO.	規格 DIMENSION	M	F	L1	L2	ID	HEX	備註 NOTE
042	1/8M×1/8F	1/8"M	1/8"F	25	19	5.5	14.26	
044	1/4M×1/4F	1/4"M	1/4"F	32	27.3	8	17.46	
046	3/8M×3/8F	3/8"M	3/8"F	35.4	30.6	11	20.64	
048	1/2M×1/2F	1/2"M	1/2"F	45.3	41	14.3	25.4	
0412	3/4M×3/4F	3/4"M	3/4"F	49.7	42.7	19.1	31.7	

※本頁全部為訂製品，需一定數量。
※線圖尺寸僅供參考，詳細尺寸以現品為準。

外銷規格接頭—彎頭(美規NPT、NPTF牙)

EXPORT TRADE BRASS CONNECTOR - ELBOW (AMERICAN)

代號：H：叉心 / M：外牙 / F：內牙 / S：喇叭口 / U：PU管

90°焊接彎頭

MALE / INLET TYPE 90°

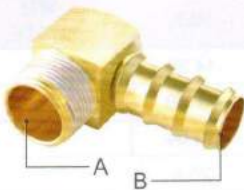

編號 ORDER NO.	規格 DIMENSION	A	B	備註 NOTE
	3/4M X 3/4H	3/4M	3/4H	

切料45°内外牙

MALE / FEMALE 45°



編號 ORDER NO.	規格 DIMENSION	M	F	ID	HEX	備註 NOTE
062	1/8M X 1/8F	1/8"M	1/8"F	5.5	14.26	
064	1/4M X 1/4F	1/4"M	1/4"F	8	17.46	
066	3/8M X 3/8F	3/8"M	3/8"F	11	20.64	
068	1/2M X 1/2F	1/2"M	1/2"F	14.3	25.4	
0612	3/4M X 3/4F	3/4"M	3/4"F	19.1	31.7	

切料F型外牙X內牙(2)

MALE F TYPE AND DOUBLE FEMALE



編號 ORDER NO.	規格 DIMENSION	M	F	L1	L2	ID	HEX	備註 NOTE
262	1/8M X 1/8F	1/8"M	1/8"F	20.5	30.8	5.5	14.26	
264	1/4M X 1/4F	1/4"M	1/4"F	28.6	42.9	8	17.46	
266	3/8M X 3/8F	3/8"M	3/8"F	32.2	46.9	11	20.64	
268	1/2M X 1/2F	1/2"M	1/2"F	40.7	60	14.3	25.4	
2612	3/4M X 3/4F	3/4"M	3/4"F	44.2	64.4	19.1	31.7	

切料三頭內牙

FEMALE TEE



編號 ORDER NO.	規格 DIMENSION	F	L1	L2	HEX	備註 NOTE
222	1/8	1/8"F	20.5	28	14.26	
224	1/4	1/4"F	28.6	39.6	17.46	
226	3/8	3/8"F	31.8	42.6	20.64	
228	1/2	1/2"F	40.7	55.6	25.4	
2212	3/4	3/4"F	44.2	58.9	31.7	

※本頁全部為訂製品，需一定數量。
※線圖尺寸僅供參考，詳細尺寸以現品為準。

外銷規格接頭—彎頭(美規NPT、NPTF牙)(歐規)

EXPORT TRADE BRASS CONNECTOR - ELBOW (AMERICAN) (EUROPEAN)

代號：H：叉心 / M：外牙 / F：內牙 / S：喇叭口 / U：PU管



切料十字內牙 FEMALE CROSS

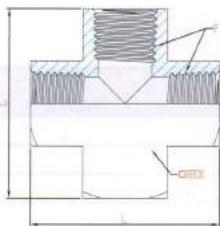
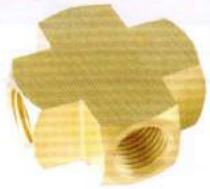

編號 ORDER NO.	規格 DIMENSION	F	L	HEX	備註 NOTE
282	1/8	1/8"F	27.3	14.26	
284	1/4	1/4"F	39.1	17.46	
286	3/8	3/8"F	42.6	20.64	
288	1/2	1/2"F	55.2	25.4	
2812	3/4	3/4"F	58.9	31.7	

園藝開關 GARDENING SWITCH



編號 ORDER NO.	規格 DIMENSION	備註 NOTE
灑水頭 Sprinkler System Use	3/4單通 One-Way	
灑水頭 Sprinkler System Use	3/4雙通 Two-Way	
灑水頭 Sprinkler System Use	活動單通 One-Way	
灑水頭 Sprinkler System Use	活動雙通 Two-Way	

一字型切料內外牙90度



編號 ORDER NO.	規格 DIMENSION	備註 NOTE
D021	1/8"	
D022	1/4"	
D023	3/8"	

歐規 EUROPEAN



編號 ORDER NO.	規格 DIMENSION	備註 NOTE
D001		



編號 ORDER NO.	規格 DIMENSION	備註 NOTE
D004		



編號 ORDER NO.	規格 DIMENSION	備註 NOTE
D002		



編號 ORDER NO.	規格 DIMENSION	備註 NOTE
D005		



編號 ORDER NO.	規格 DIMENSION	備註 NOTE
D003		



編號 ORDER NO.	規格 DIMENSION	備註 NOTE
D006		

※本頁全部為訂製品，需一定數量。
※線圖尺寸僅供參考，詳細尺寸以現品為準。

外銷規格接頭—開關

EXPORT TRADE BRASS CONNECTOR - SWITCH

代號：H：叉心 / M：外牙 / F：內牙 / S：喇叭口 / U：PU管

針閥

NEEDLE VALVE



編號 ORDER NO.	規格 DIMENSION	A	備註 NOTE
D007	1/4"	1/4"	

減壓閥

DECOMPRESSION VALVE



編號 ORDER NO.	規格 DIMENSION	A	備註 NOTE
D008	1/2"	1/2"	
D009	3/4"	3/4"	
D010	1"	1"	
D011	1 1/4"	1 1/4"	
D012	2 1/2"	2 1/2"	
D013	2"	2"	

瓦斯三通開關

GAS THREE HEAD SWITCH



編號 ORDER NO.	規格 DIMENSION	A	備註 NOTE
D014	1/4"	1/4"	

冷氣閥門

COOL AIR VALVE



編號 ORDER NO.	規格 DIMENSION	A	備註 NOTE
D015	1/4"	1/4"	
D016	3/8"	3/8"	
D017	1/2"	1/2"	

瓦斯開關

GAS SWITCH



編號 ORDER NO.	規格 DIMENSION	A	備註 NOTE
D018	3/4"	3/4"	

外銷規格接頭 鍛造彎頭

EXPORT TRADE BRASS CONNECTOR - FORGING ELBOW

代號：H：叉心 / M：外牙 / F：內牙 / S：喇叭口 / U：PU管

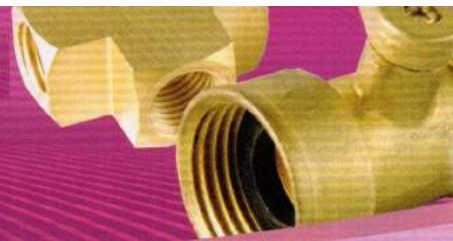

90°雙外牙 (NPT)

DOUBLE MALE 90° ELBOW



編號 ORDER NO.	規格 DIMENSION	A	B	牌價 PRICE	包裝 BAG	備註 NOTE
P-70	1/8" M X 1/8" M	1/8" M	1/8" M	48	100	
P-71	1/4" M X 1/8" M	1/4" M	1/8" M	48	100	
P-72	1/4" M X 1/4" M	1/4" M	1/4" M	48	100	
P-73	3/8" M X 1/4" M	3/8" M	1/4" M	56	50	
P-74	3/8" M X 3/8" M	3/8" M	3/8" M	56	50	
P-75	1/2" M X 1/4" M	1/2" M	1/4" M	100	50	
P-76	1/2" M X 3/8" M	1/2" M	3/8" M	100	50	
P-77	1/2" M X 1/2" M	1/2" M	1/2" M	100	30	
P-77-1	3/4" M X 3/4" M	3/4" M	3/4" M		15	

90°外牙插心 (NPT)

MALE / INLET TYPE 90°

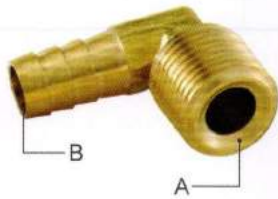

編號 ORDER NO.	規格 DIMENSION	A	B	牌價 PRICE	包裝 BAG	備註 NOTE
P-60-1	1/8" M X 3/16" H	1/8" M	3/16" H	40	100	
P-60	1/8" M X 1/4" H	1/8" M	1/4" H	48	100	
P-61	1/8" M X 5/16" H	1/8" M	5/16" H	48	100	
P-61-1	1/8" M X 3/8" H	1/8" M	3/8" H	48	100	
P-62	1/4" M X 1/4" H	1/4" M	1/4" H	48	50	
P-63	1/4" M X 5/16" H	1/4" M	5/16" H	48	50	
P-64	1/4" M X 3/8" H	1/4" M	3/8" H	48	50	
P-64-1	1/4" M X 1/2" H	1/4" M	1/2" H	100	50	
P-65-1	3/8" M X 1/4" H	3/8" M	1/4" H	56	50	
P-65	3/8" M X 5/16" H	3/8" M	5/16" H	56	50	
P-66	3/8" M X 3/8" H	3/8" M	3/8" H	56	50	
P-66-1	3/8" M X 1/2" H	3/8" M	1/2" H	100	50	
P-67	1/2" M X 5/16" H	1/2" M	5/16" H	100	50	
P-68	1/2" M X 3/8" H	1/2" M	3/8" H	100	50	
P-69	1/2" M X 1/2" H	1/2" M	1/2" H	100	50	
P-69-1	1/2" M X 5/8" H	1/2" M	5/8" H	120	30	
P-69-2	1/2" M X 3/4" H	1/2" M	3/4" H	120	30	
P-69-3	3/4" M X 3/8" H	3/4" M	3/8" H	170	20	
P-69-4	3/4" M X 1/2" H	3/4" M	1/2" H	170	20	
P-69-5	3/4" M X 5/8" H	3/4" M	5/8" H	170	15	
P-69-6	3/4" M X 3/4" H	3/4" M	3/4" H	170	15	
P-69-7	3/4" M X 1" H	3/4" M	1" H	190	10	
P-69-8	1" M X 3/4" H	1" M	3/4" H	260	10	
P-69-9	1" M X 1" H	1" M	1" H	260	10	

瓦斯Y三通

GAS THREE HEAD Y TYPE



※內牙插管可訂製

編號 ORDER NO.	規格 DIMENSION	A	B	C	牌價 PRICE	包裝 BAG	備註 NOTE
D019	Y5/16 X 5/16 X 5/16	5/16	5/16	5/16			

瓦斯T三通

GAS THREE HEAD T TYPE



編號 ORDER NO.	規格 DIMENSION	A	B	C	牌價 PRICE	包裝 BAG	備註 NOTE
D020	Y5/16 X 5/16 X 5/16	5/16	5/16	5/16			

※本頁全部為訂製品，需一定數量。
※線圖尺寸僅供參考，詳細尺寸以現品為準。



外銷規格接頭—鍛造彎頭

EXPORT TRADE BRASS CONNECTOR - FORGING ELBOW

代號：H：叉心 / M：外牙 / F：內牙 / S：喇叭口 / U：PU管

90°雙插管 DOUBLE INLET TYPE



編號 ORDER NO.	規格 DIMENSION	A	B	牌價 PRICE	包裝 BAG	備註 NOTE
	L1/4	1/4	1/4			
	L5/16	5/16	5/16			
	L3/8	3/8	3/8			
	L1/2	1/2	1/2			
	L3/4	3/4	3/4			

T插管 INLET T TYPE



編號 ORDER NO.	規格 DIMENSION	A	牌價 PRICE	包裝 BAG	備註 NOTE
	1/4	1/4			
	5/16	5/16			
	3/8	3/8			
	1/2	1/2			
	3/4	3/4			

尼卜 DOUBLE MALE



編號 ORDER NO.	規格 DIMENSION	A	牌價 PRICE	包裝 BAG	備註 NOTE
	1/4	1/4			
	3/4	3/4			

加鑲套外牙插管 MALE / INLET TYPE WITH PVC WASHER



編號 ORDER NO.	規格 DIMENSION	A	B	牌價 PRICE	包裝 BAG	備註 NOTE
	1/8 X 1/4	1/8	1/4			
	3/4 X 5/16	3/4	5/16			

45°外牙插管 MALE / INLET TYPE 45°



編號 ORDER NO.	規格 DIMENSION	牌價 PRICE	包裝 BAG	備註 NOTE

平面直角接頭 MALE FEMALE RIGHT ANGLED CONNECTOR



編號 ORDER NO.	規格 DIMENSION	牌價 PRICE	包裝 BAG	備註 NOTE
				訂製品 Custom-Made

※本頁全部為訂製品，需一定數量。
※線圖尺寸僅供參考，詳細尺寸以現品為準。